

MP_PDB-300L-05

Podstawa klatkowa na dwie beczki 300L

Cage base for two barrels 300L

Käfigboden für zwei Fässer 300L

Base de la cage pour deux tonneaux 300L

Základna klece pro dva sudy 300L

Producent: Marxam Project

www.marxam.eu

www.marxam-project.com

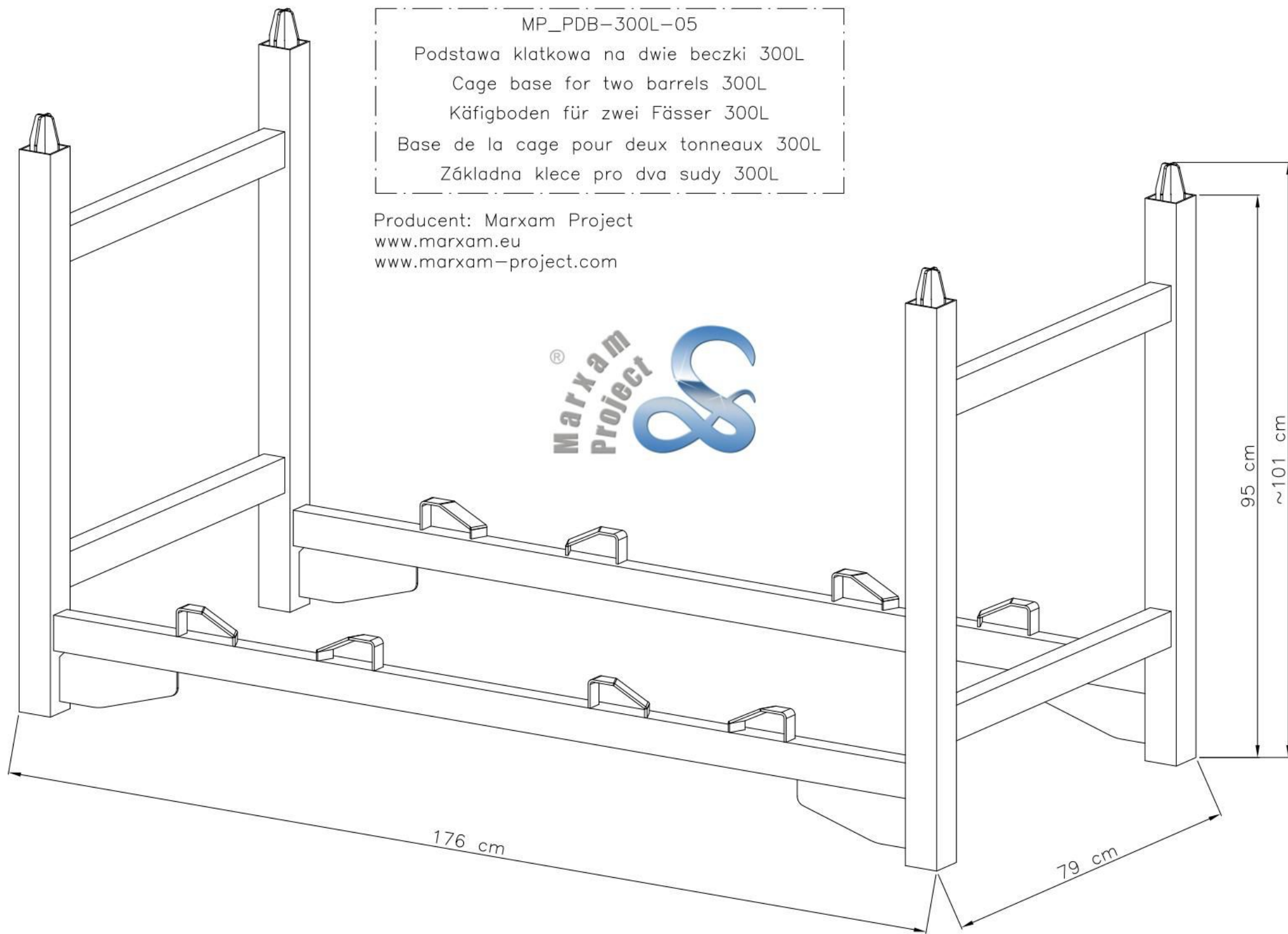

MP_PDB-300L-05

Podstawa klatkowa na dwie beczki 300L

Cage base for two barrels 300L

Käfigboden für zwei Fässer 300L

Base de la cage pour deux tonneaux 300L

Základna klece pro dva sudy 300L

Producent: Marxam Project

www.marxam.eu

www.marxam-project.com

Masa: 44,9 kg

Maksymalne obciążenie: 3 000 kg

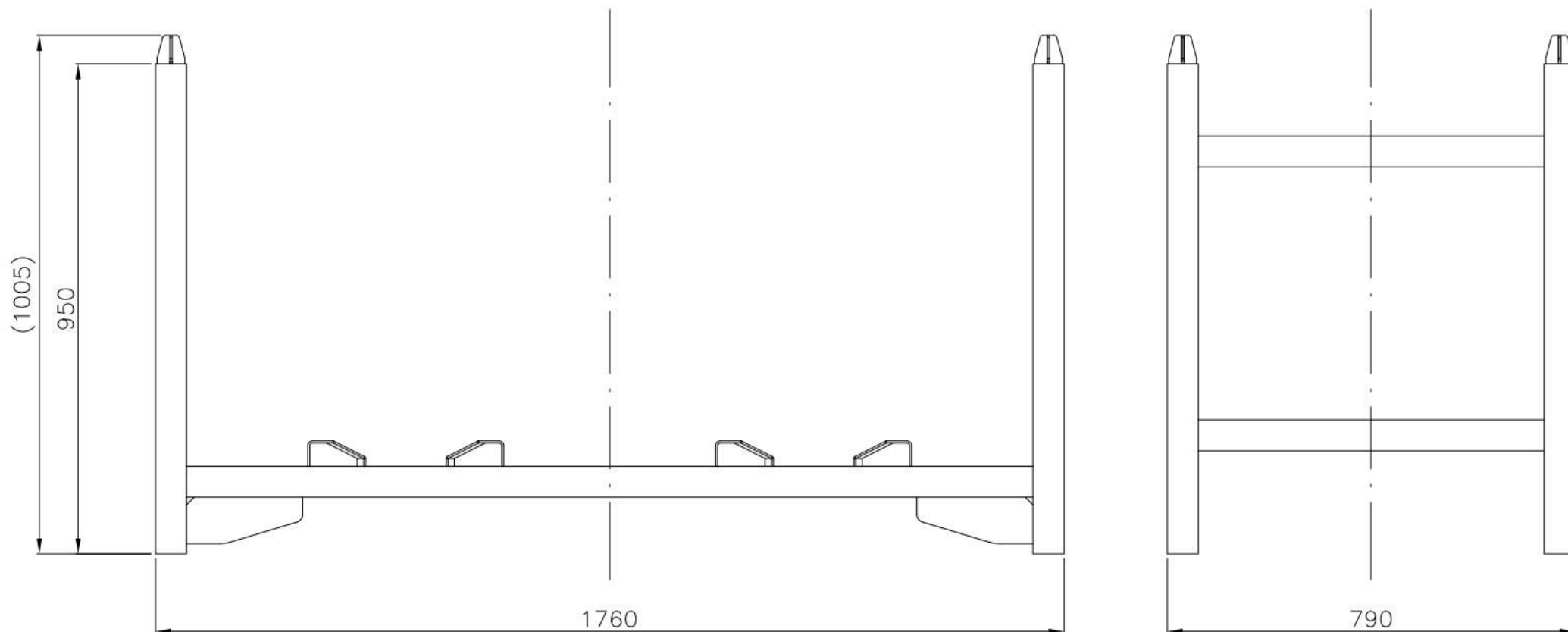
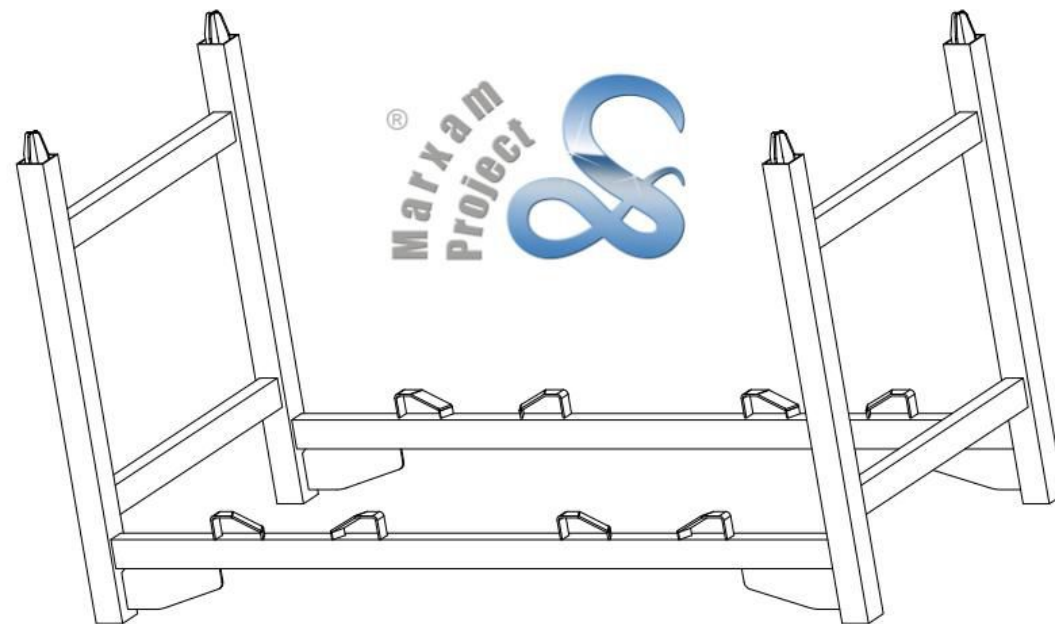

MP_PDB-300L-05

Podstawa klatkowa na dwie beczki 300L

Cage base for two barrels 300L

Käfigboden für zwei Fässer 300L

Base de la cage pour deux tonneaux 300L

Základna klece pro dva sudy 300L

Producent: Marxam Project

www.marxam.eu

www.marxam-project.com

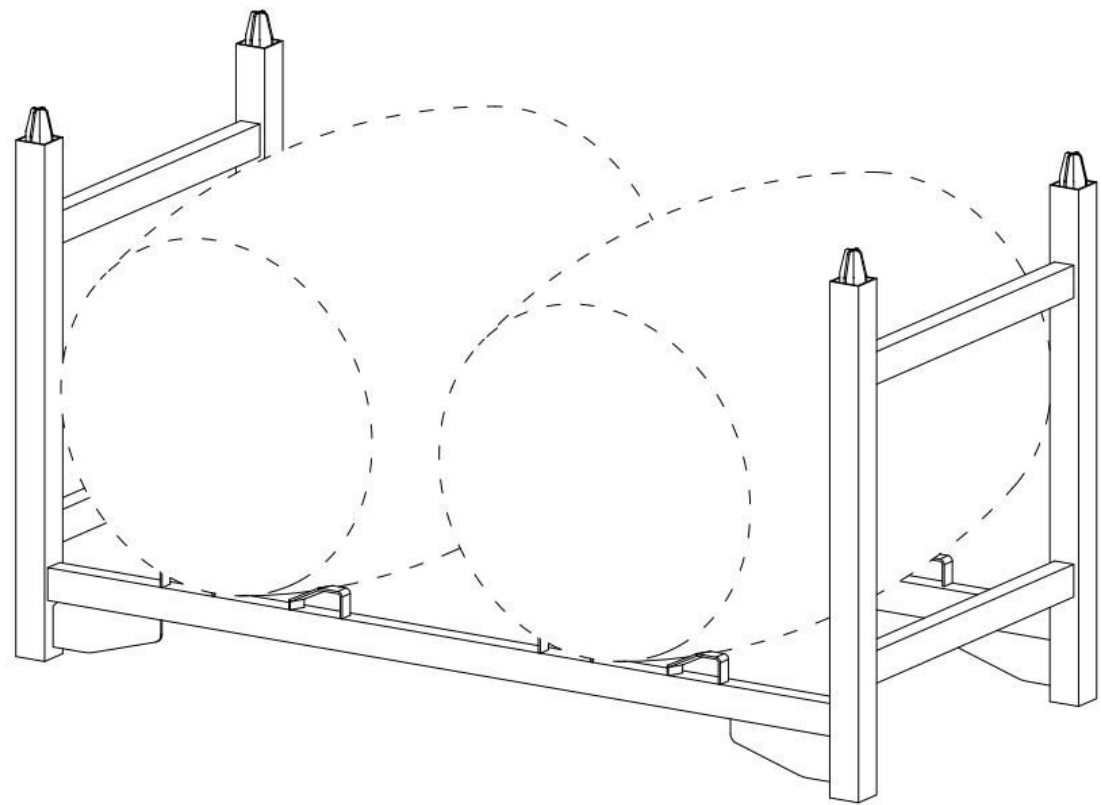

Barrel 300 L

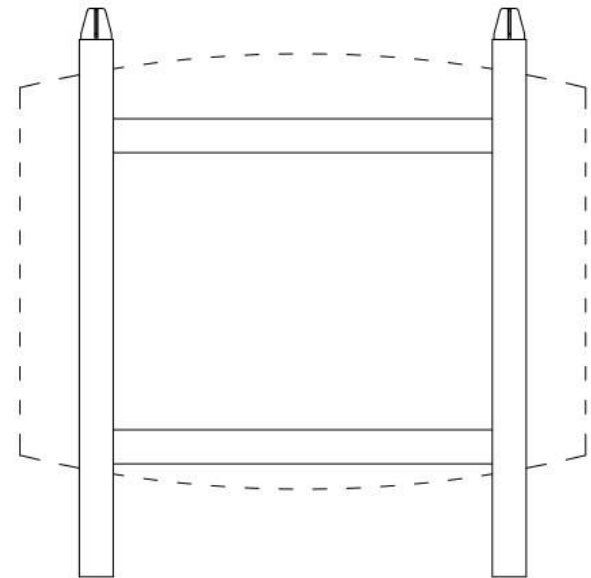
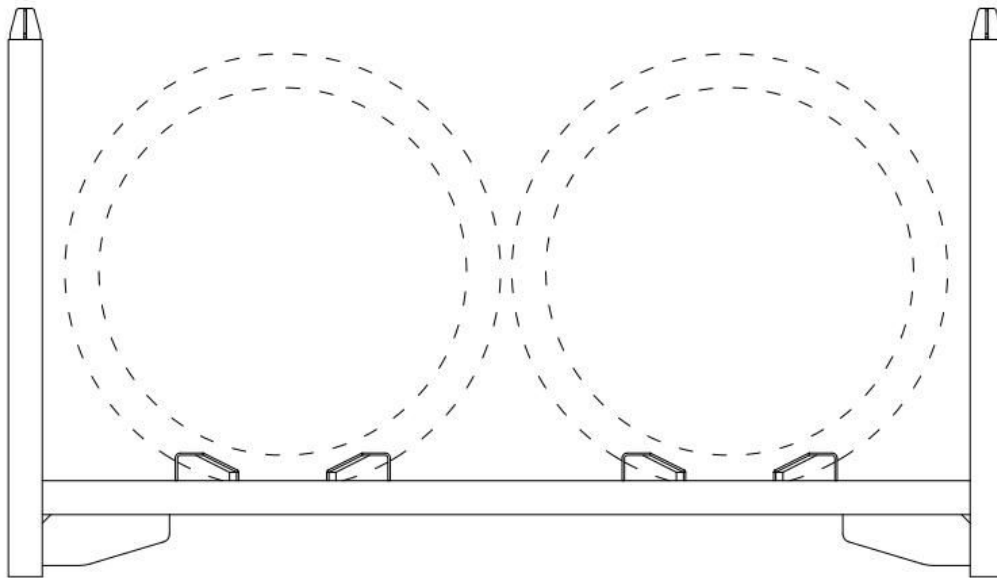

MP_PDB-300L-05

Podstawa klatkowa na dwie beczki 300L

Cage base for two barrels 300L

Käfigboden für zwei Fässer 300L

Base de la cage pour deux tonneaux 300L

Základna klece pro dva sudy 300L

Producent: Marxam Project
www.marxam.eu
www.marxam-project.com

