

MP_PDB-110L-06

Podstawa klatkowa na trzy beczki 110L

Cage base for three barrels 110L

Käfigboden für drei Fässer 110L

Base de la cage pour trois tonneaux 110L

Základna klece pro tři sudy 110L



Producent: Marxam Project

www.marxam.eu

www.marxam-project.com

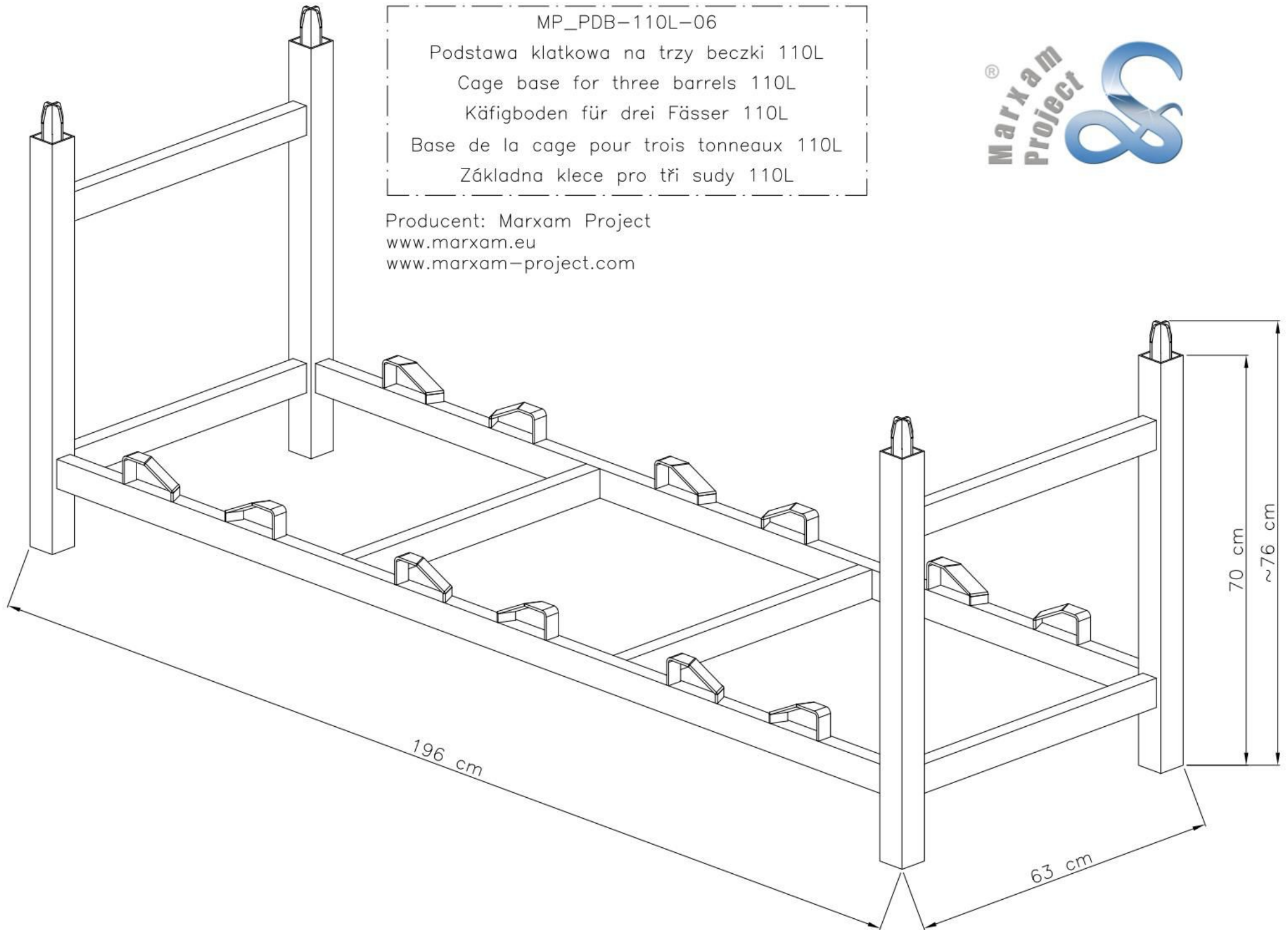

MP_PDB-110L-06

Podstawa klatkowa na trzy beczki 110L

Cage base for three barrels 110L

Käfigboden für drei Fässer 110L

Base de la cage pour trois tonneaux 110L

Základna klece pro tři sudy 110L

Producent: Marxam Project
www.marxam.eu
www.marxam-project.com

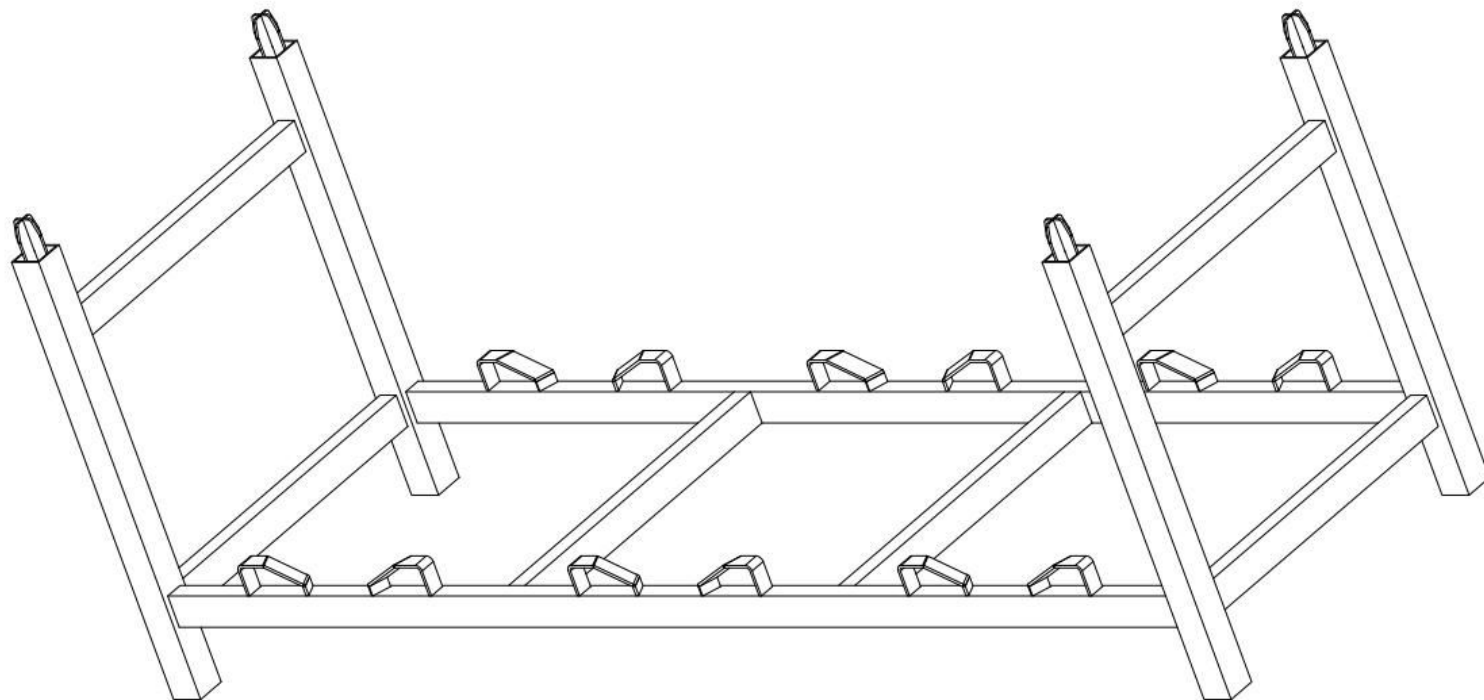

Masa: 41,5 kg
Maksymalne obciążenie: 2 000 kg

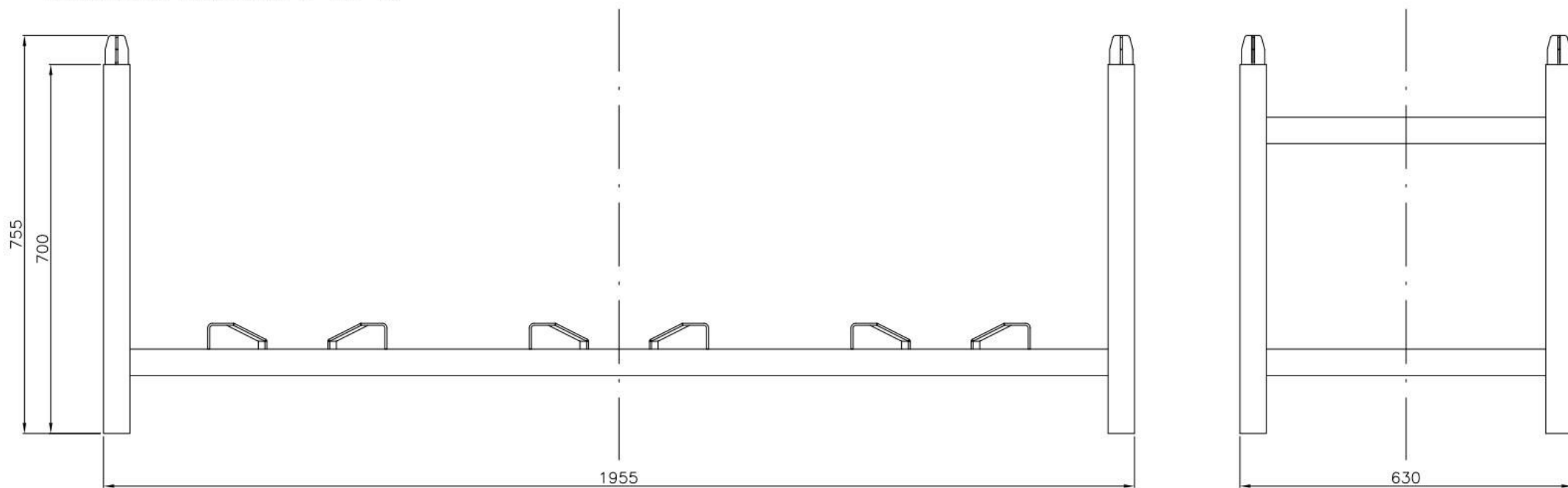

MP_PDB-110L-06

Podstawa klatkowa na trzy beczki 110L

Cage base for three barrels 110L

Käfigboden für drei Fässer 110L

Base de la cage pour trois tonneaux 110L

Základna klece pro tři sudy 110L

Producent: Marxam Project

www.marxam.eu

www.marxam-project.com

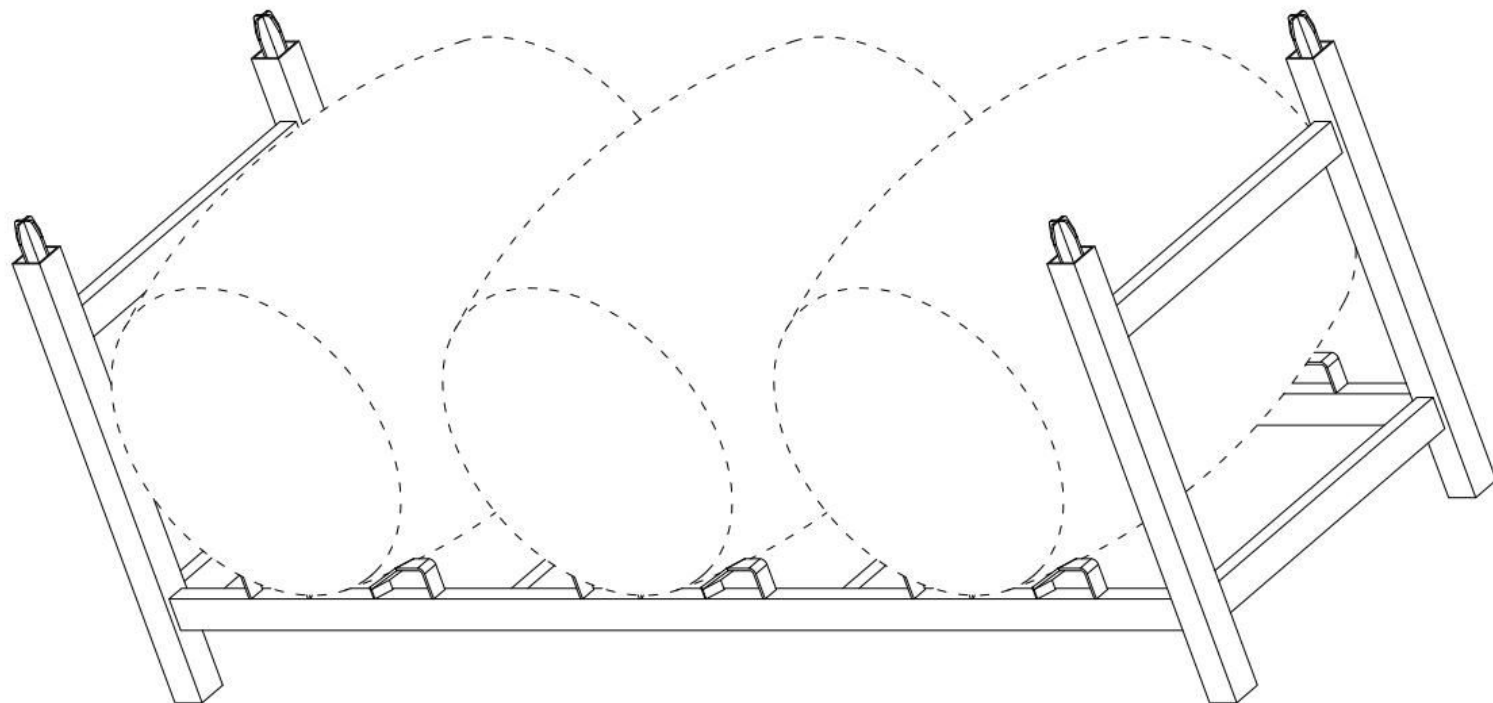

Barrel 110 L

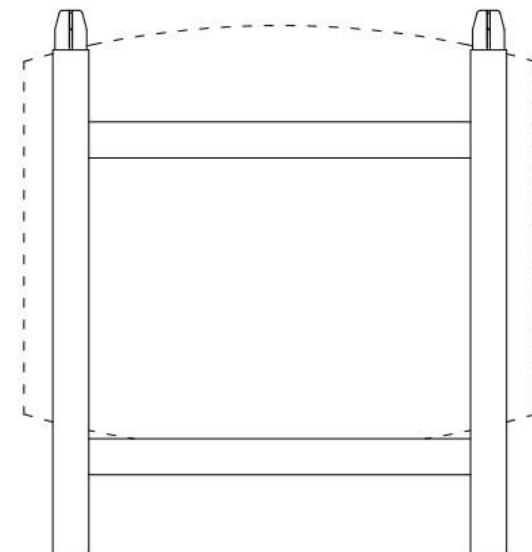
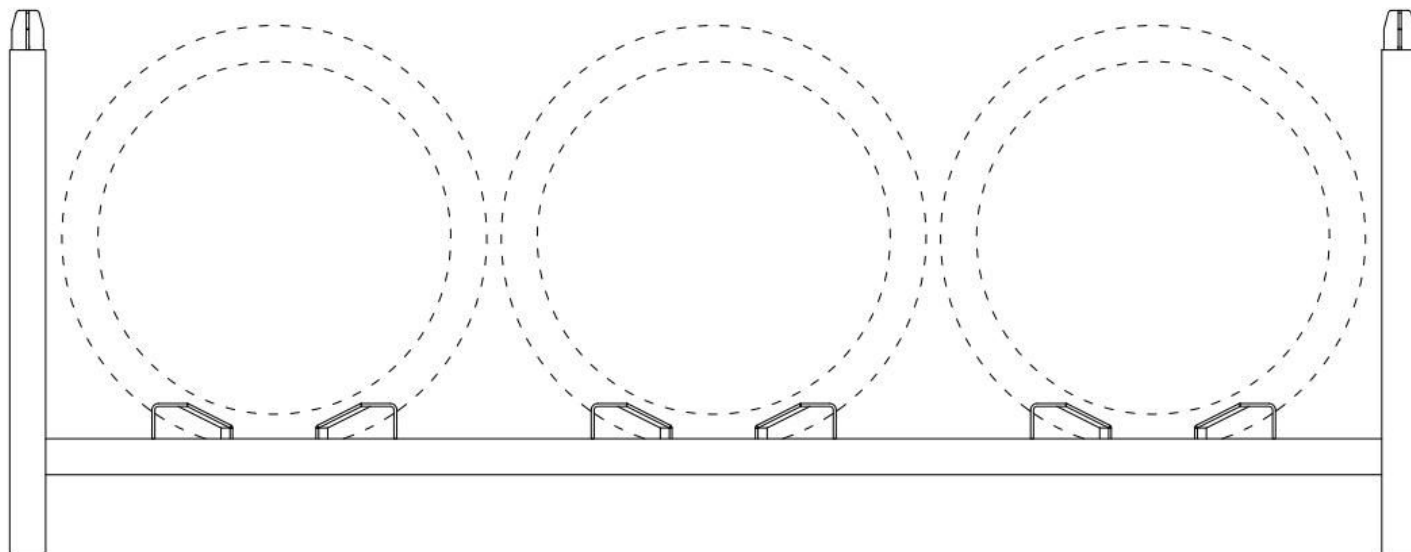

MP_PDB-110L-06

Podstawa klatkowa na trzy beczki 110L

Cage base for three barrels 110L

Käfigboden für drei Fässer 110L

Base de la cage pour trois tonneaux 110L

Základna klece pro tři sudy 110L

Producent: Marxam Project

www.marxam.eu

www.marxam-project.com

