

MP_PDB-225L-07
Podstawa klatkowa na cztery beczki 225L
Cage base for four barrels 225L
Käfigboden für vier Fässer 225L
Base de la cage pour quatre tonneaux 225L
Základna klece pro čtyři sudy 225L

Producent: Marxam Project
www.marxam.eu
www.marxam-project.com

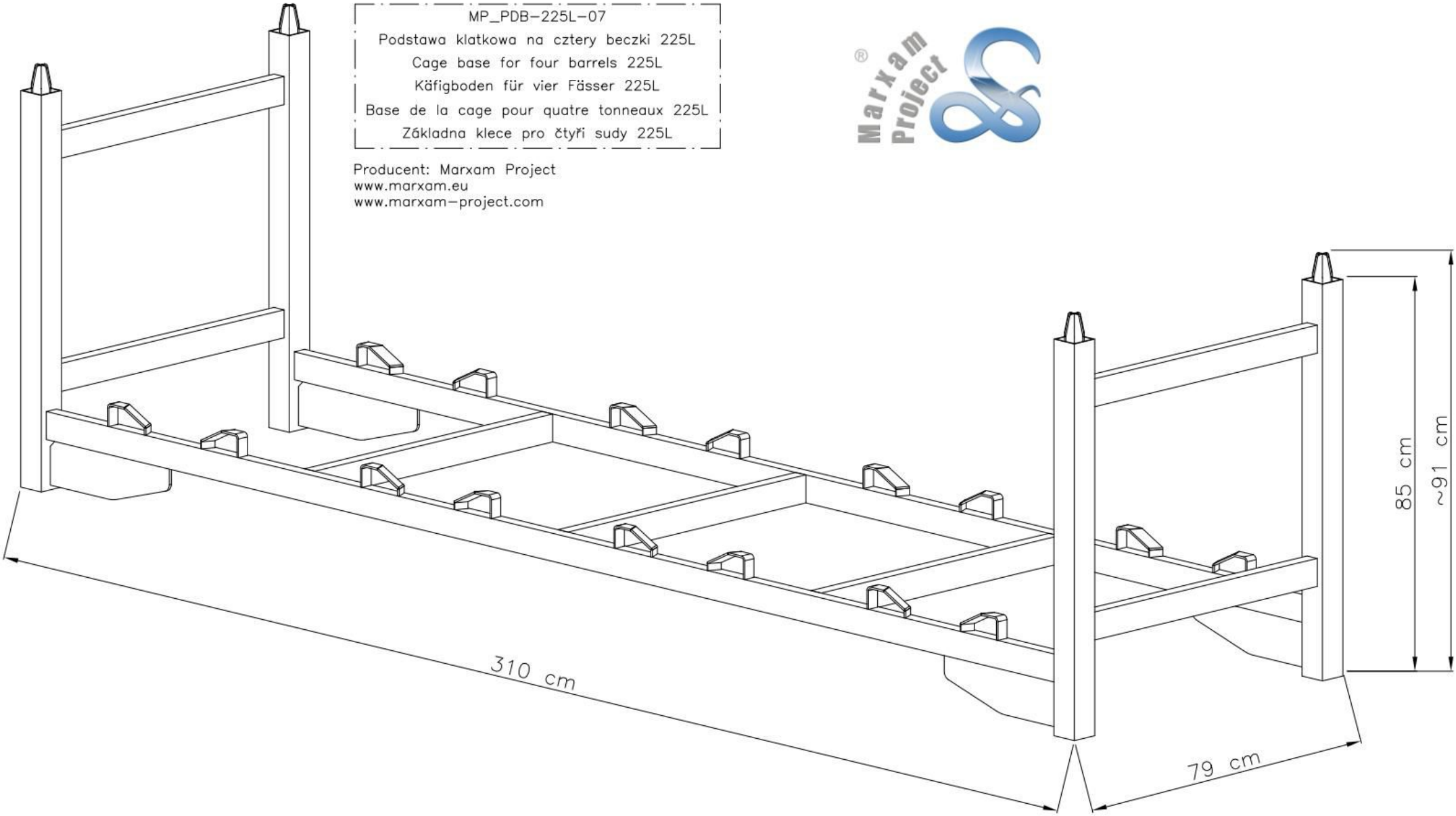

MP_PDB-225L-07

Podstawa klatkowa na cztery beczki 225L

Cage base for four barrels 225L

Käfigboden für vier Fässer 225L

Base de la cage pour quatre tonneaux 225L

Základna klece pro čtyři sudy 225L

Producent: Marxam Project

www.marxam.eu

www.marxam-project.com

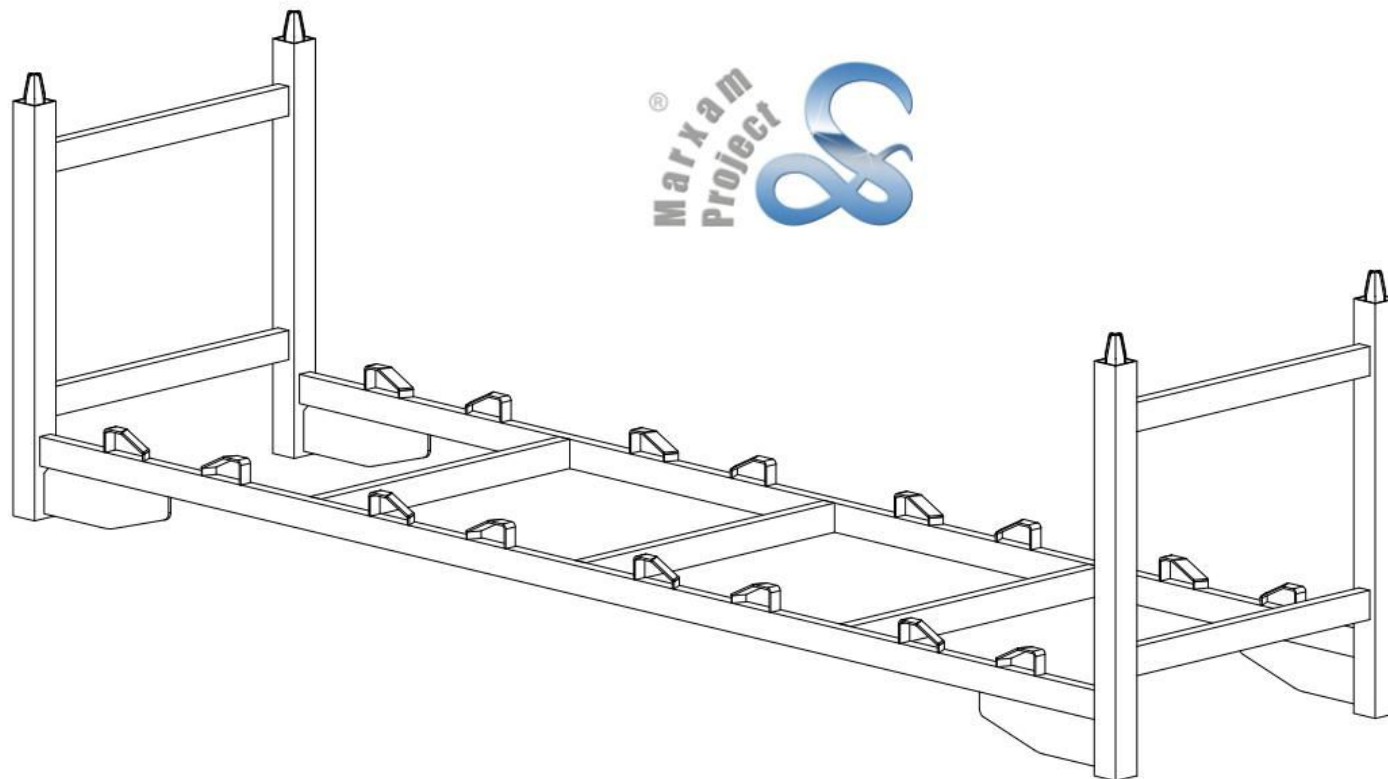

Masa: 73,5 kg

Maksymalne obciążenie: 5 000 kg

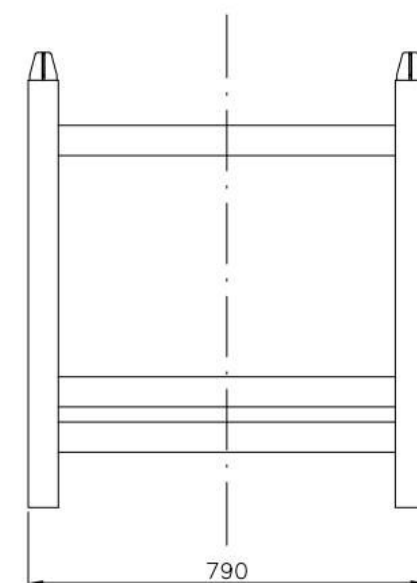
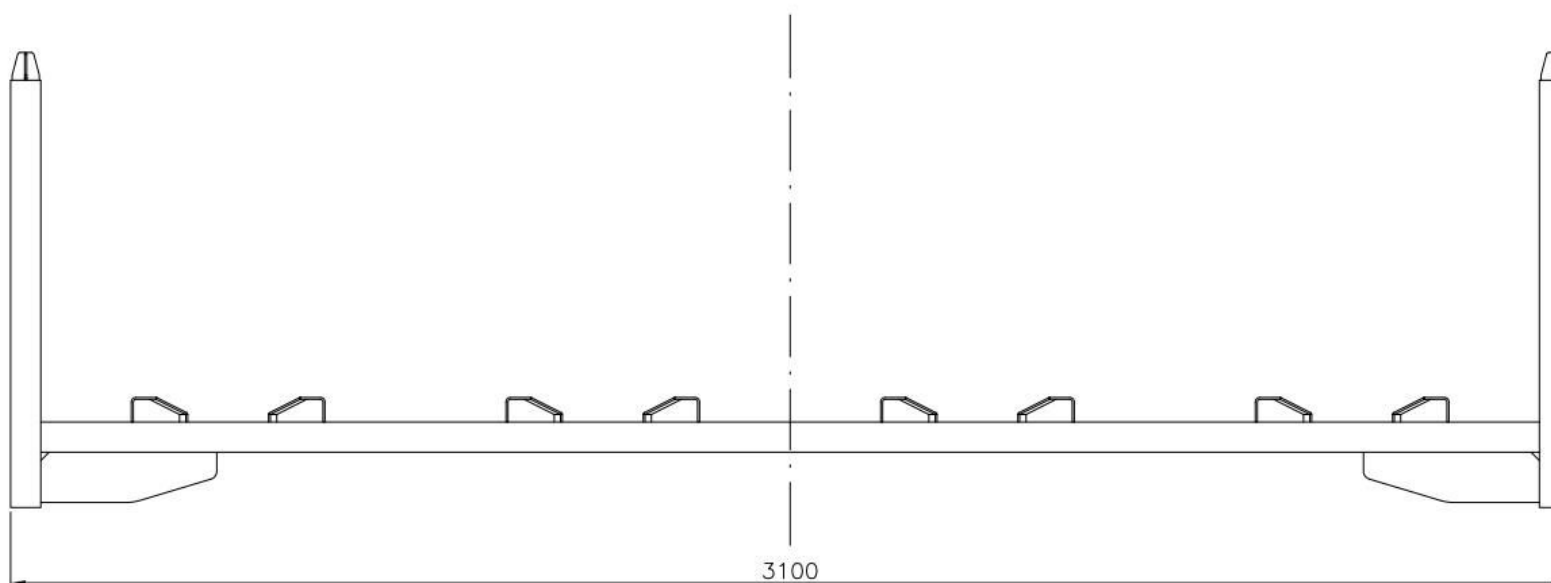

MP_PDB-225L-07

Podstawa klatkowa na cztery beczki 225L

Cage base for four barrels 225L

Käfigboden für vier Fässer 225L

Base de la cage pour quatre tonneaux 225L

Základna klece pro čtyři sudy 225L

Producent: Marxam Project
www.marxam.eu
www.marxam-project.com

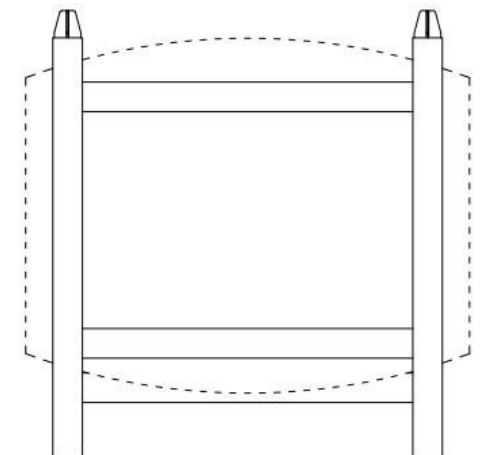
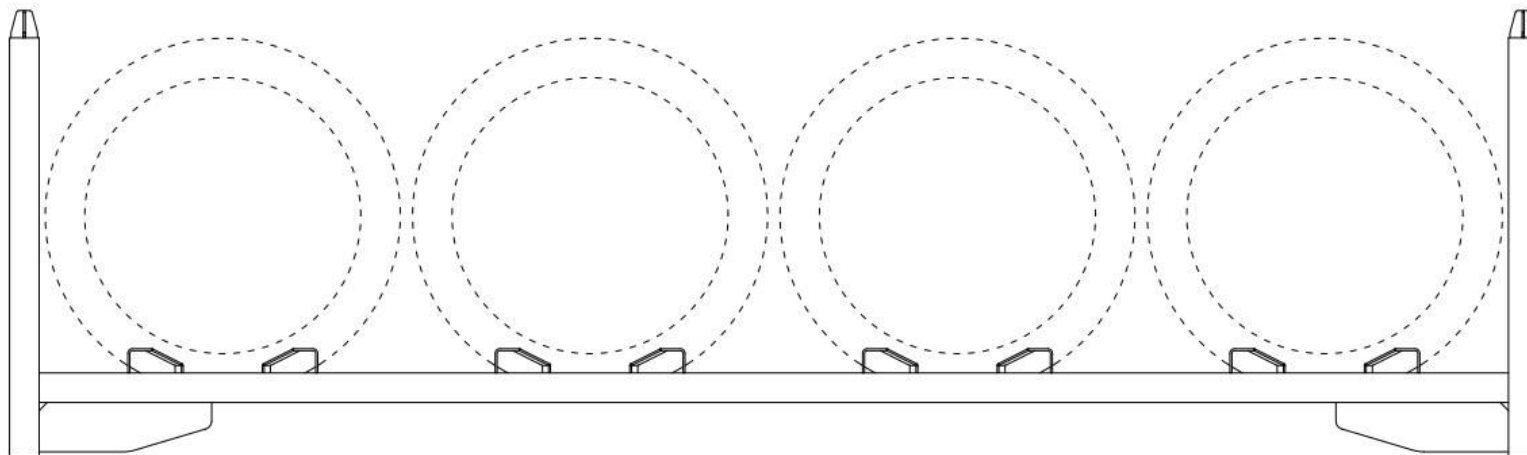
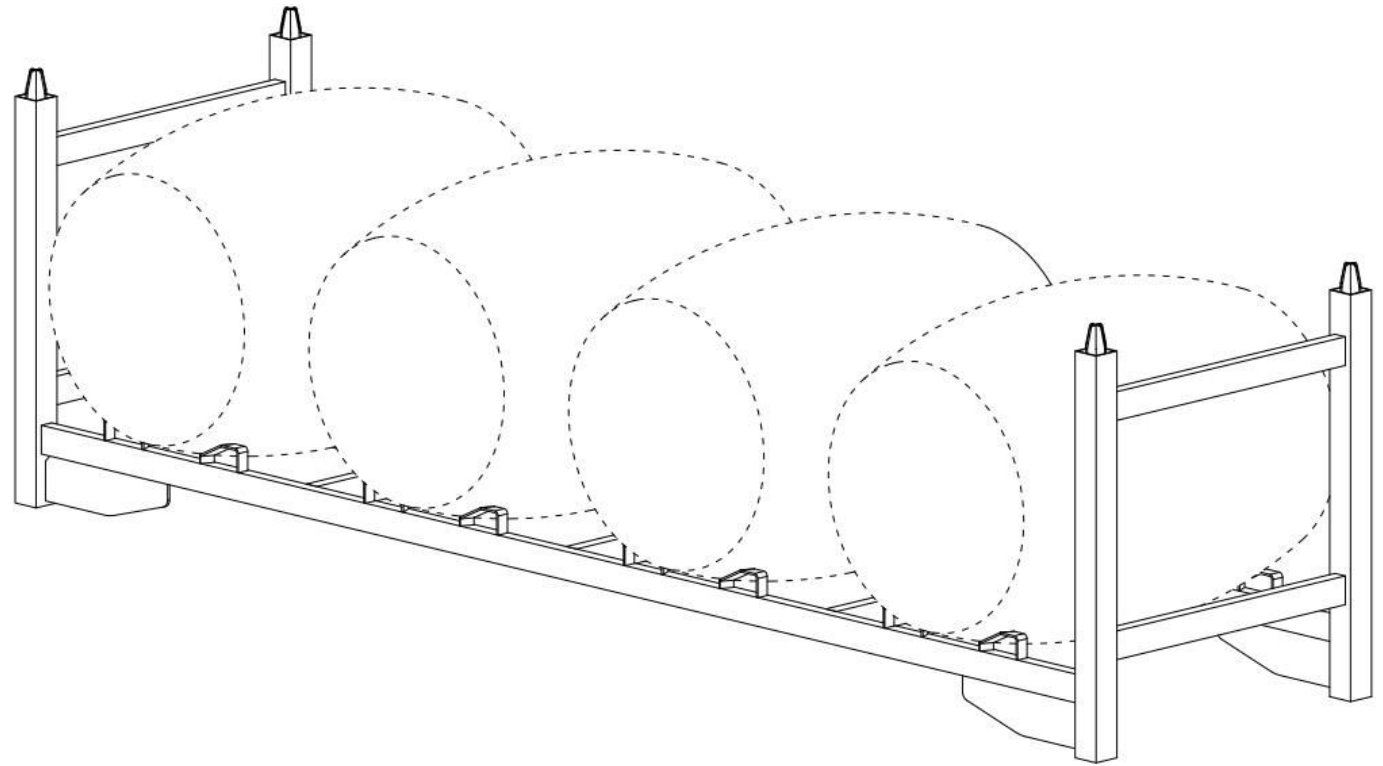

MP_PDB-225L-07

Podstawa klatkowa na cztery beczki 225L

Cage base for four barrels 225L

Käfigboden für vier Fässer 225L

Base de la cage pour quatre tonneaux 225L

Základna klece pro čtyři sudy 225L

Producent: Marxam Project

www.marxam.eu

www.marxam-project.com

