

MP_PDB-50L-02

Podstawa podwójna na dwie beczki 50L

Double base for two barrels 50L

Doppelsockel für zwei Fässer 50L

Double base pour deux tonneaux 50L

Dvojitá základna pro dva sudy 50L

Producent: Marxam Project

www.marxam.eu

www.marxam-project.com

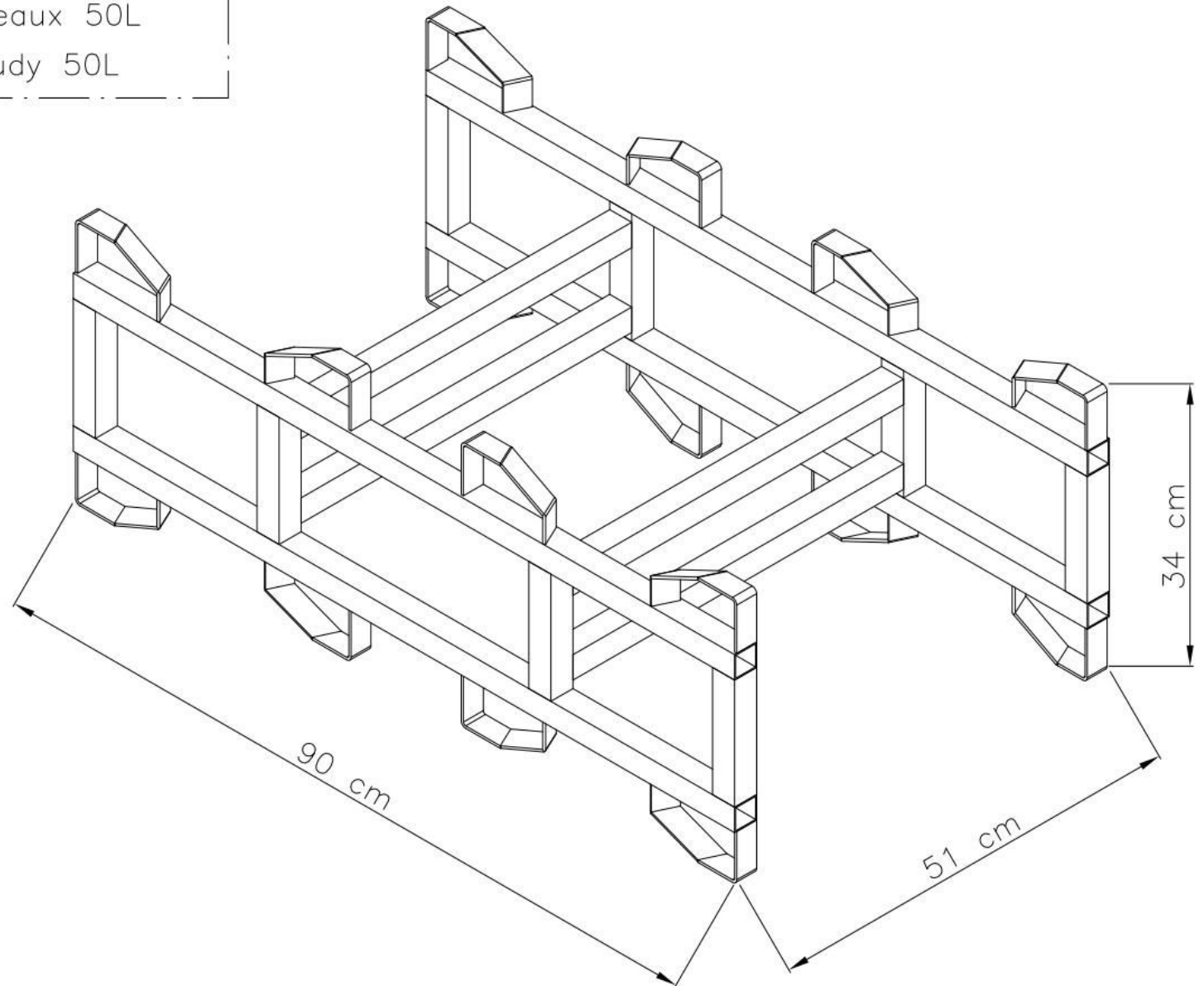

MP_PDB-50L-02

Podstawa podwójna na dwie beczki 50L

Double base for two barrels 50L

Doppelsockel für zwei Fässer 50L

Double base pour deux tonneaux 50L

Dvojitá základna pro dva sudy 50L



Producent: Marxam Project
www.marxam.eu
www.marxam-project.com

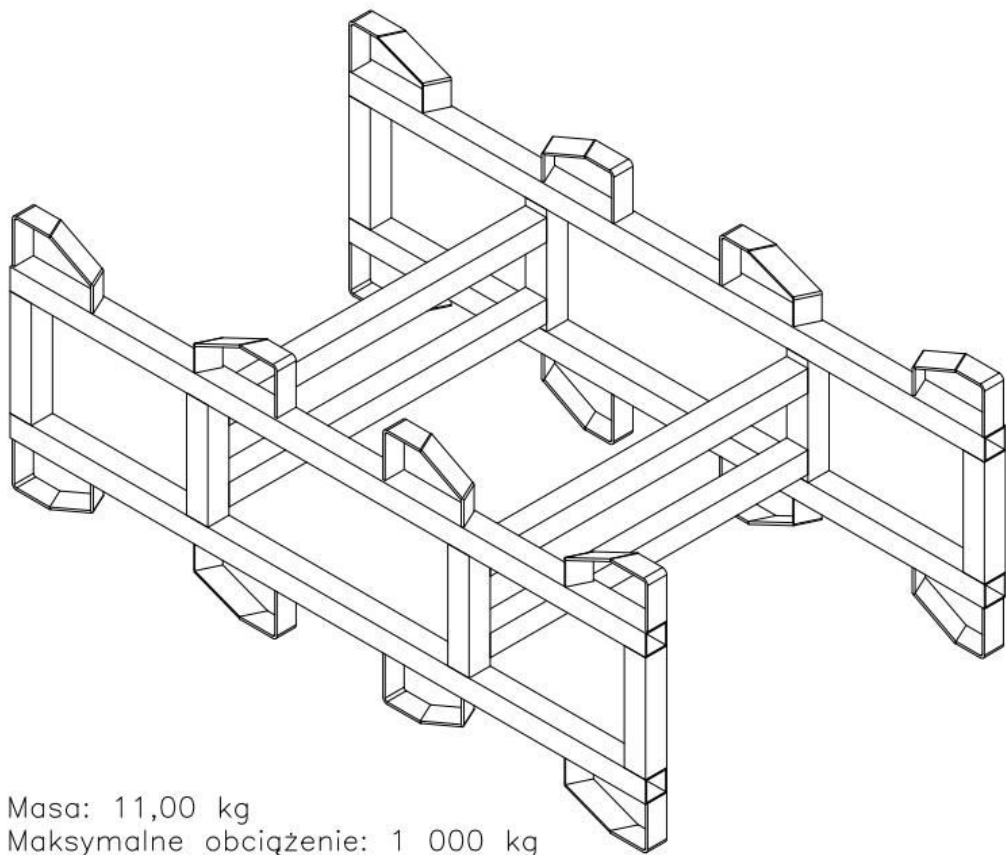

Masa: 11,00 kg

Maksymalne obciążenie: 1 000 kg

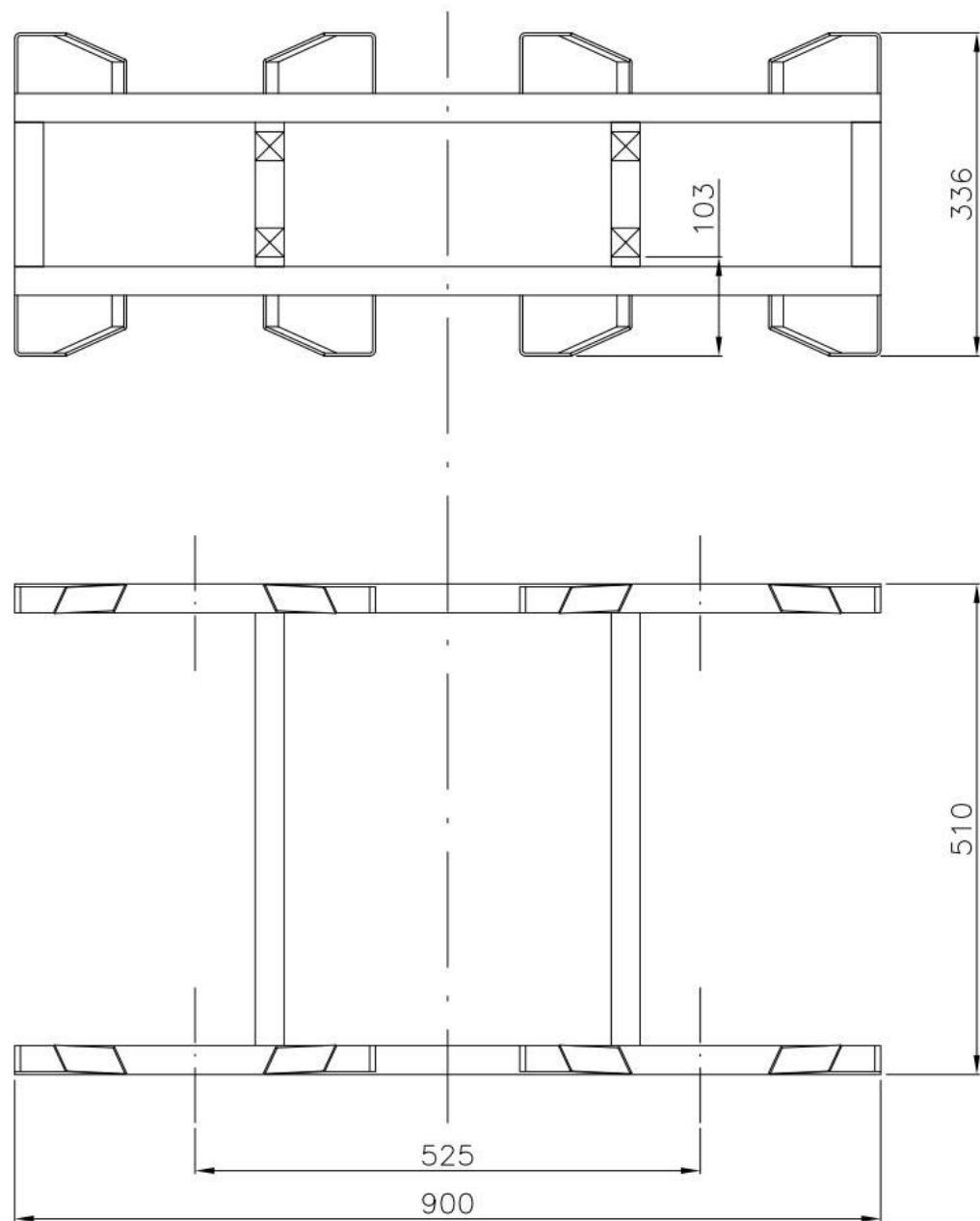

MP_PDB-50L-02

Podstawa podwójna na dwie beczki 50L

Double base for two barrels 50L

Doppelsockel für zwei Fässer 50L

Double base pour deux tonneaux 50L

Dvojitá základna pro dva sudy 50L

Producent: Marxam Project

www.marxam.eu

www.marxam-project.com

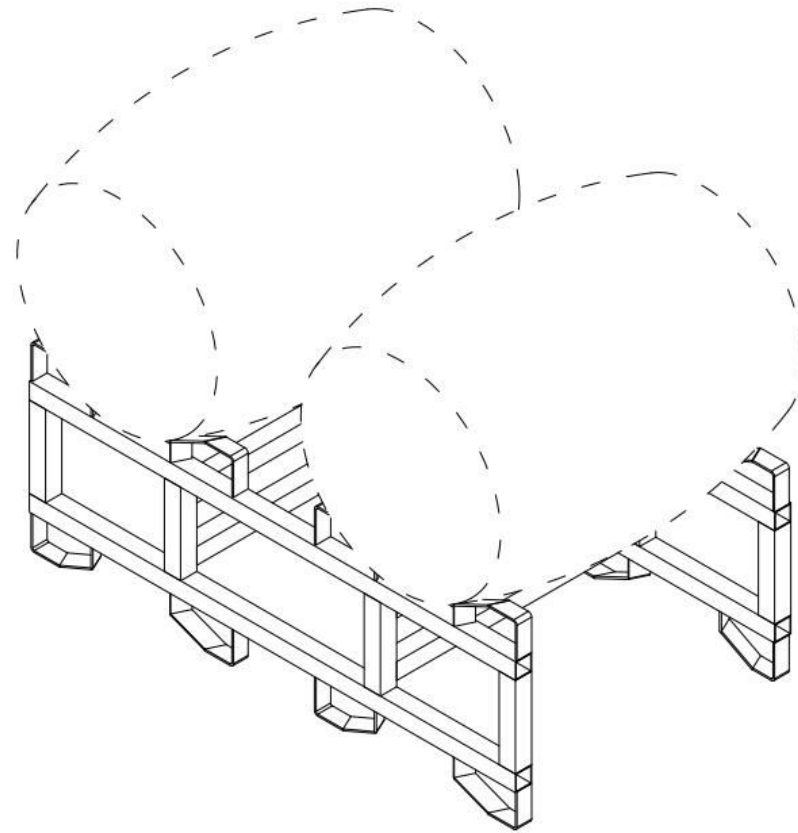

Barrel 50 L

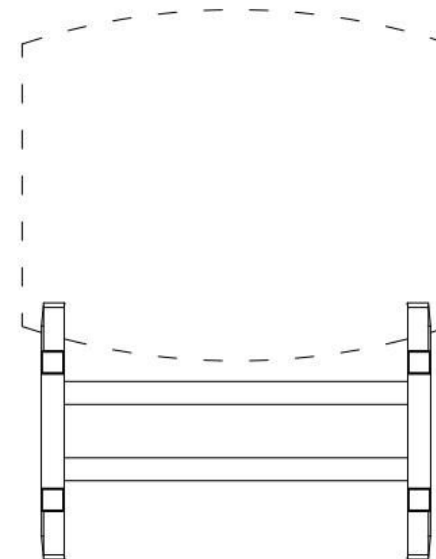
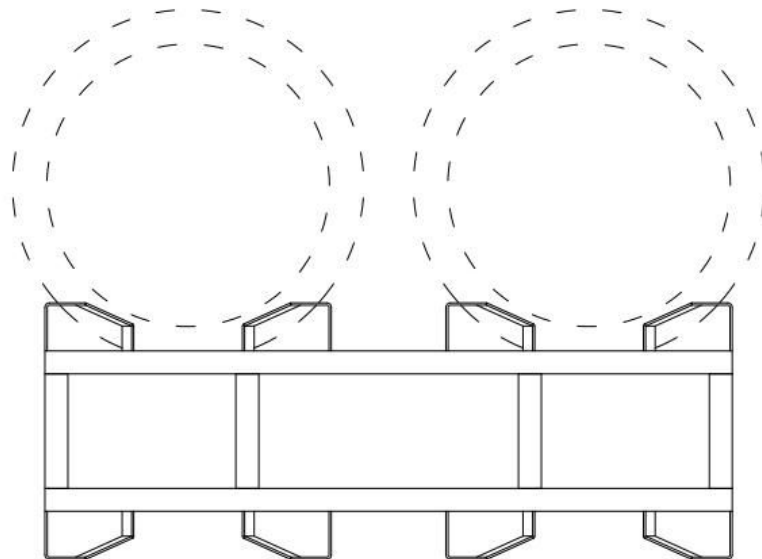

MP_PDB-50L-02

Podstawa podwójna na dwie beczki 50L

Double base for two barrels 50L

Doppelsocle für zwei Fässer 50L

Double base pour deux tonneaux 50L

Dvojitá základna pro dva sudy 50L

Producent: Marxam Project
www.marxam.eu
www.marxam-project.com

