



Double pumps and 200° rotatable cylinder assy



Relief knob with two speeds action



Small space when folded



Handle holder



Easy moving when folded



Nylon wheel with fiber glass



Model	Capacity	Net Weight	Packing Size	A	B	B1	C	D	E	F	G	H	Rmin	Rmax
SC600	600kgs	73kgs	155x36x24cm	1540	2300	2100	1375	942	92	665	370	404	955	1350

SC600

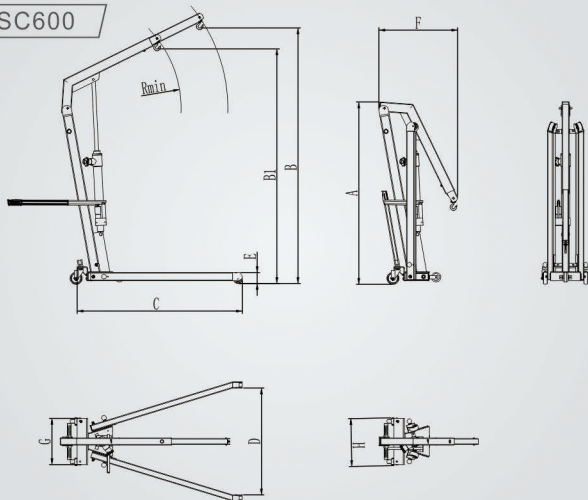

## Features

- Two speeds actions which can meet the requirements of EN1494 well
- Hard chrome plated cylinder and piston rod for long life
- Hand operated dead man's release for optimum safety whilst lowering
- Built-in safety overload valve
- Five gears on the jib arm provide users more choices
- Foldable within seconds for quick and easy storage, only takes up a small space when folded
- Fitted with 2 castors and 2 fixed wheels for easy operation even with max load
- Lifting hook pivots 360°