



# SILCA NEWS 02/2021

ALL THE NEW KEYS, AUTOMOTIVE SOLUTIONS, KEY CUTTING MACHINES, SOFTWARE UPDATES AND MUCH MORE

## Contents

<u>New Keys</u>	<u>1</u>	<u>New Unocode F Series</u>	<u>5, 6, 7, 8</u>
<u>Smart Pro Application Update</u>	<u>2</u>	<u>SKP PRO 1/2021 Update</u>	<u>9, 10</u>
<u>ADS2297 Software Update for Nissan®</u>	<u>3, 4</u>	<u>Accessories for Key Cutting Machines</u>	<u>11-16</u>

## UNOCODE **F** Series

*F900 - F800 - F600 - F400*



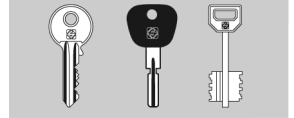

New Keys / Chiavi Nuove / Neue Schlüssel / Nouvelles Clés / Llaves Nuevas / Chaves Novas

FOR: PER:	CISA	FOR: PER:	HUF																					
	   <b>CS121R</b>  ELSA		   <b>HU181P</b>  																					
			<table border="1" style="margin-left: auto; margin-right: auto;"> <thead> <tr> <th colspan="3">HARLEY DAVIDSON</th> </tr> <tr> <th>MODEL</th> <th>FROM</th> <th>TO</th> </tr> </thead> <tbody> <tr> <td>BREACKOUT</td> <td>2018</td> <td></td> </tr> <tr> <td>LOW RIDER</td> <td>2018</td> <td></td> </tr> <tr> <td>SOFTAIL</td> <td>2018</td> <td></td> </tr> <tr> <td>SPORT GLIDE</td> <td>2018</td> <td></td> </tr> <tr> <td>STREET BOB</td> <td>2018</td> <td></td> </tr> </tbody> </table>	HARLEY DAVIDSON			MODEL	FROM	TO	BREACKOUT	2018		LOW RIDER	2018		SOFTAIL	2018		SPORT GLIDE	2018		STREET BOB	2018	
HARLEY DAVIDSON																								
MODEL	FROM	TO																						
BREACKOUT	2018																							
LOW RIDER	2018																							
SOFTAIL	2018																							
SPORT GLIDE	2018																							
STREET BOB	2018																							

FOR / PER
<b>CISA</b> (IT) ELSA
<b>HUF</b> (DE)
<b>YALE</b> (IT)
<a href="http://www.silca.biz">www.silca.biz</a>

FOR: PER:	YALE
	   <b>YA107R</b>  

ALL THE KEYS DISPLAYED ARE AVAILABLE ALSO IN THE SILCA "NEW KEY COLLECTION"



## UPDATE YOUR SMART PRO NOW!

**FREE Update**

Data update with new vehicle applications / Aggiornamento dati con nuove applicazioni veicolo / Datenaktualisierung mit neuen Fahrzeug-Anwendungen / Mise à jour des données avec des nouvelles applications de véhicules / Actualización de datos con nuevas aplicaciones de vehículos / Atualização de dados com novas aplicações de veículos

REGION	MANUFACTURER*	MODEL*	START YEAR	END YEAR	KEY TYPE	SW MODULE
Europe	Hyundai	Sonata	2005	2011	BLADE	ADS2188
Africa	Renault	Kwid	2018	2020	BLADE	ADS2259
Africa	Volkswagen	Polo	2011	2014	BLADE	ADS2292
Asia	Toyota	Dyna	2007	2020	BLADE	ADS2174
Asia	Ford	Mustang	2015	2017	PROX	ADS2209
Asia	Honda	Fit Shuttle	2015	2020	PROX	ADS2193
Australia	Kia	Carnival	2006	2007	BLADE	ADS2118
Australia	Kia	Optima	2011	2015	PROX-SLOT	ADS2147
Australia	Toyota	Land Cruiser	2012	2015	PROX	ADS2150
Australia	Toyota	Voxy	2014	2017	BLADE-REMOTES	ADS2150
Australia	Honda	CRV	2017	2020	BLADE	ADS2166
Canada	BMW	X5	2007	2013	SLOT	ADS2183
Canada	Kia	Sportage	2021	2020	BLADE	ADS2196
New Zealand	Mazda	Atenza	2008	2012	PROX	ADS2162
New Zealand	Subaru	Impreza	2007	2011	BLADE	ADS2127
S. America	Dodge	RAM V700	2012	2020	BLADE	ADS2258
S. America	Opel-Vauxhall	Vivaro	2019	2020	BLADE	ADS2188
S. America	Fiat	Palio Adventure	2013	2020	BLADE	ADS2121
S. America	Opel	Crossland X	2017	2020	BLADE	ADS2188
S. America	Suzuki	Swift	2017	2020	PROX	ADS2233
S. America	Renault	Kangoo	2018	2020	BLADE	ADS2259
USA	BMW	X5	2007	2013	SLOT	ADS2183
USA	Kia	K5	2021	2021	PROX	ADS2280
USA	Chevrolet	Trailblazer	2020	2020	BLADE	ADS2279

\* All the brands and product names mentioned in this flyer are registered trademarks exclusive property of authorized manufacturers. Said trademarks or trade names are nominated only for the purposes of information in order to be rapidly identified. / All information and illustrations in this flyer are for guidance only. Silca reserves the right to alter products, software, designs or information to improve the product's quality.



## Key Programming Software Update Nissan® 2020 ADS2297 - Code D754587AD



**UK** Advanced Diagnostics is pleased to announce an update to the ADS2297 key programming software for Nissan® to include bladed keys for the Micra and Kicks models.

The ADS2297 software programs both proximity and bladed keys for various Nissan® vehicles without the need for online access or dealer codes. The software supports all keys lost situations (no working keys required).

**IT** Advanced Diagnostics ha sviluppato un nuovo aggiornamento per il software ADS2297 per Nissan®, consentendo di programmare chiavi con canna metallica per i modelli Micra e Kicks.

Il software ADS2297 consente di programmare chiavi di prossimità e con chiave metallica per diversi modelli Nissan® senza richiedere l'accesso a risorse online o l'utilizzo di codici del costruttore. È inoltre possibile creare nuove chiavi anche in assenza dell'originale. Non è infatti necessaria una chiave funzionante per programmare un nuovo radiocomando.

**DE** Advanced Diagnostics hat das Software-Update ADS2297 für die Programmierung von Schlüsseln für Nissan® entwickelt. Mit dem Update können Sie Schlüssel für die Modelle Micra und Kicks programmieren.

Die Software ADS2297 programmiert die Metall- und Keyless-Go-Schlüssel für verschiedene Nissan® Modelle, ohne Zugriff auf Online-Ressourcen oder die Verwendung von Hersteller-codes. Kein funktionierender Schlüssel ist erforderlich, um die Programmierung vorzunehmen.

**FR** Advanced Diagnostics a développé la mise à jour du logiciel ADS2297 dédié à la programmation des clés Nissan®, qui vous permet de programmer des clés pour les modèles Micra et Kicks.

Le logiciel ADS2297 programme les clés en métal et de proximité pour différents modèles Nissan® sans avoir besoin d'accéder aux ressources en ligne ou d'utiliser les codes du fabricant. Il est possible de créer de nouvelles clés même quand on a perdu l'original. En fait, vous n'avez pas besoin d'une clé en ordre de marche pour programmer une nouvelle télécommande.

**PT** A Advanced Diagnostics desenvolveu a atualização do software ADS2297 dedicado à programação de chaves para Nissan®, que permite programar chaves para os modelos Micra e Kicks.

O software ADS2297 programa chaves de metal e de proximidade para vários modelos Nissan® sem exigir acesso a recursos online ou o uso de códigos de fabricante. É possível criar novas chaves mesmo na ausência do original. De fato, não é necessária uma chave que funciona para efectuar a programação.

**ES** Advanced Diagnostics ha desarrollado la actualización software ADS2297 para la programación de llaves Nissan®, que le permite programar llaves para los modelos Micra y Kicks.

El software ADS2297 programa llaves sin proximidad y llaves de proximidad para diferentes modelos Nissan® sin requerir acceso a recursos en línea o el uso de códigos de fabricante. Se puede crear nuevas llaves incluso en ausencia del original. De hecho, no necesitas una llave arrancando para poder realizar el proceso de programación.

### OFFER DETAILS

Cable	ADC2000
Software category	C
Other accessories required	No



## Key Programming Software Update Nissan® 2020 ADS2297 - Code D754587AD

**TABLE**

REGION	Car Icon	Key Icon	Transponder Icon	PIN ✓	PIN	PRO	Other Icon	
<b>Europe</b>	<b>Nissan® Micra K14 (Bladed key) 2017 to 2020</b> Transponder: ID49-1E Blade: NSN14 - Remote: RN-N01R11	<b>NEW</b>	✓	✓	✓	✓	ADC2000	✗
Europe	Nissan® Micra K14 (Proximity-Push Button key) 2017 to 2020	✓	✓	✓	✓	✓	ADC2000	✗
<b>Middle East</b>	<b>Nissan® Kicks P15 (Bladed key)</b> <b>2018 to 2020</b>	<b>NEW</b>	✓	✓	✓	✓	ADC2000	✗
Middle East	Nissan® Kicks P15 (Proximity-Push Button key) 2018 to 2020	✓	✓	✓	✓	✓	ADC2000	✗
Asia	Nissan® Versa N18 (Proximity-Push Button key) 2020 to 2020	✓	✓	✓	✓	✓	ADC2000	✗
<b>Canada</b>	<b>Nissan® Kicks P15 (Bladed key)</b> <b>2018 to 2020</b>	<b>NEW</b>	✓	✓	✓	✓	ADC2000	✗
Canada	Nissan® Kicks P15 (Proximity-Push Button key) 2018 to 2020	✓	✓	✓	✓	✓	ADC2000	✗
Canada	Nissan® Versa N18 (Proximity-Push Button key) 2020 to 2020	✓	✓	✓	✓	✓	ADC2000	✗
<b>S. America</b>	<b>Nissan® Kicks P15 (Bladed key)</b> <b>2018 to 2020</b>	<b>NEW</b>	✓	✓	✓	✓	ADC2000	✗
S. America	Nissan® Kicks P15 (Proximity-Push Button key) 2018 to 2020	✓	✓	✓	✓	✓	ADC2000	✗
S. America	Nissan® Pathfinder R52 (Proximity-Push Button key) 2020 to 2020	✓	✓	✓	✓	✓	ADC2000	✗
S. America	Nissan® Versa N18 (Proximity-Push Button key) 2020 to 2020	✓	✓	✓	✓	✓	ADC2000	✗
USA	Infiniti® QX80 Z62 (Proximity-Push Button key) 2020 to 2020	✓	✓	✓	✓	✓	ADC2000	✗
<b>USA</b>	<b>Nissan® Kicks P15 (Bladed key)</b> <b>2018 to 2020</b>	<b>NEW</b>	✓	✓	✓	✓	ADC2000	✗
USA	Nissan® Kicks P15 (Proximity-Push Button key) 2018 to 2020	✓	✓	✓	✓	✓	ADC2000	✗
USA	Nissan® Versa N18 (Proximity-Push Button key) 2020 to 2020	✓	✓	✓	✓	✓	ADC2000	✗

© All the brands and product names mentioned in this flyer are registered trademarks exclusive property of authorized manufacturers. Said trademarks or trade names are nominated only for the purposes of information in order to be rapidly identified. / All information and illustrations in this flyer are for guidance only. Silca reserves the right to alter products, software, designs or information to improve the product's quality.

[www.silca.biz](http://www.silca.biz) - [www.silca-automotive.com](http://www.silca-automotive.com) - [www.advanced-diagnostics.com](http://www.advanced-diagnostics.com)

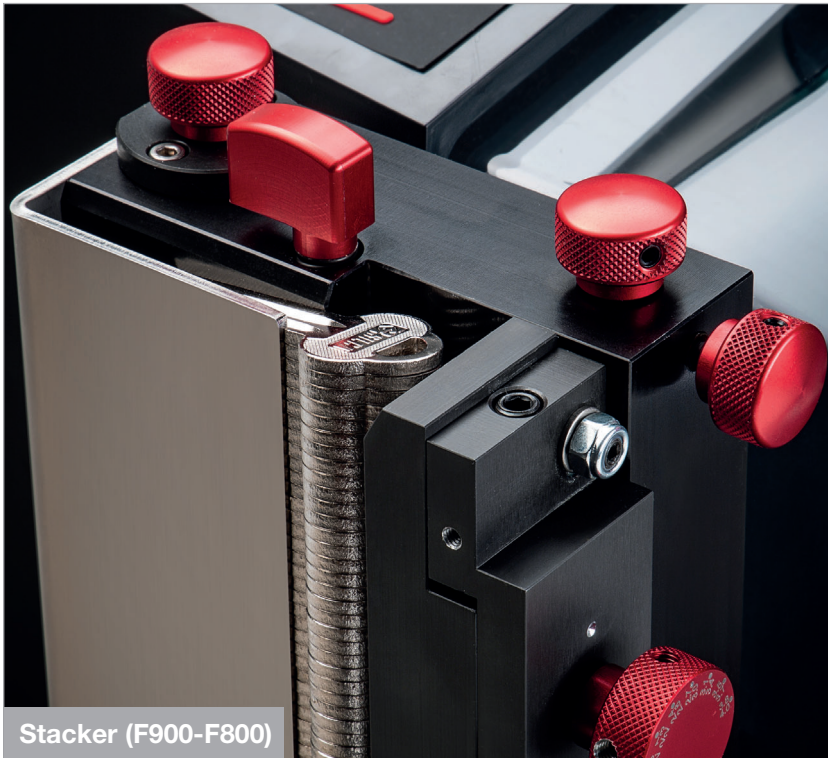
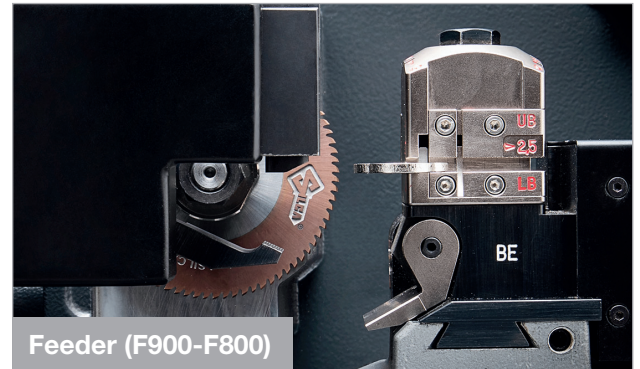
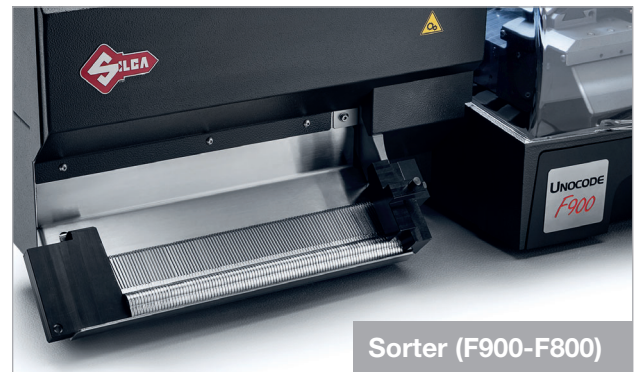
**Stacker (F900-F800)****Feeder (F900-F800)****Sorter (F900-F800)**

## MAKE EVERY MINUTE COUNT WITH SILCA'S UNIQUE UNOCODE F SERIES

Designed for specialist locksmiths, Silca's latest electronic key cutting machines automate and simplify the complete key duplication process to improve the speed and quality of service to your customer. **Faster key duplication means significantly improved returns on each key sold for you.**

Progettate per gli specialisti della duplicazione, le nuove macchine elettroniche Silca consentono di automatizzare e semplificare l'intero processo di duplicazione di una chiave, migliorando la velocità e la qualità del servizio offerto al cliente. E non solo: **una duplicazione più veloce significa anche maggiori guadagni su ogni chiave venduta.**

Mit den neuesten, für Schlüsselprofilen entwickelten elektronischen Silca Fräsmaschinen können Sie den Vorgang der Schlüsselduplikation automatisieren und vereinfachen, so die Geschwindigkeit und Qualität der dem Kunden angebotenen Dienstleistung verbessert. **Schnellere Duplikation bedeutet auch einen höheren Gewinn pro verkauftem Schlüssel.**

Conçues pour les reproducteurs professionnels, les machines à tailler les clés électroniques exclusive Silca sont en mesure d'automatiser et de simplifier tout le processus de taille d'une clé tout en améliorant la rapidité et la qualité du service offert au client. **Ajoutons qu'à une taille plus rapide correspondent des bénéfices majeurs sur chaque clé vendue.**

Diseñadas para los especialistas de la duplicación, las últimas duplicadoras electrónicas Silca automatizan y simplifican todo el proceso de duplicación de una llave, mejorando la velocidad y la calidad del servicio ofrecido al cliente. Y mucho más: **una duplicación más rápida significa también mayores ingresos por cada llave vendida.**

Projectadas para os especialistas da duplicação, as últimas duplicadoras electrónicas Silca automatizam e simplificam o inteiro procedimento de duplicação de uma chave, melhorando a velocidade e a qualidade do serviço proporcionado ao cliente. E não só: **uma duplicação mais rápida também significa ganhos maiores em cada chave vendida.**

> [More info on unocodeseries.com](https://www.unocodeseries.com)

## UNOCODE F SERIES - RANGE

### THE RANGE

- **Unocode F900** is the truly all-in-one solution for duplicating flat keys, automating the key feeding, engraving, cutting and sorting.
- **Unocode F800** automates the duplication by code of flat keys.
- **Unocode F600** optimizes the cutting and engraving process of flat keys.
- **Unocode F400** copies by code, by original and by decoding flat residential and vehicle keys.

### LA GAMMA

- **Unocode F900** è la soluzione completa ed efficiente per duplicare chiavi piatte, automatizzando il processo di alimentazione, incisione, cifratura e scarico ordinato.
- **Unocode F800** automatizza la duplicazione a codice di chiavi piatte.
- **Unocode F600** ottimizza i processi di cifratura e incisione delle chiavi piatte.
- **Unocode F400** copia a codice, da originale e con decodifica le chiavi piatte residenziali e veicolo.

### DIE PALETTE

- **Unocode F900** ist die effiziente Komplettlösung für das Kopieren von Flachschlüsseln. Sie ermöglicht es Ihnen, den Bestückungs-, Gravur-, Fräs- und geordneten Ablagevorgang der Schlüssel zu automatisieren.
- **Unocode F800** automatisiert das Kopieren nach Code von Flachschlüsseln.
- **Unocode F600** optimiert die Fräsung- und Gravurprozesse von Flachschlüsseln.
- **Unocode F400** kopiert Wohn- und Fahrzeugflachschlüssel nach Code, nach Original und mit Decodierung.

### LA GAMME

- **Unocode F900** est la solution complète et efficiente pour copier des clés plates qui automatise le processus de chargement, gravure, taillage et déchargement ordonné des clés.
- **Unocode F800** automatise la reproduction par code des clés plates.
- **Unocode F600** optimise les processus de taillage et de gravure des clés plates.
- **Unocode F400** reproduit par code, à partir de l'original et avec décodage les clés plates résidentielles et de véhicule.

### LA GAMA

- **Unocode F900** es la solución completa y eficiente para copiar llaves planas, al permitir disponer de un proceso automático de carga, grabado, corte y descarga ordenada de las llaves.
- **Unocode F800** automatiza la duplicación por código de llaves planas.
- **Unocode F600** optimiza los procesos de corte y grabado de llaves planas.
- **Unocode F400** copia por código, desde original y con descodificación llaves planas residenciales y de vehículos.

### A GAMA

- **Unocode F900** é a solução completa e eficiente para a cópia de chaves planas, permitindo-lhe tornar automático o procedimento de carregamento, gravação, corte e descarga ordenada.
- **Unocode F800** automatiza a duplicação por código de chaves planas.
- **Unocode F600** otimiza os processos de corte e gravação de chaves planas.
- **Unocode F400** cópia por código, do original e com descodificação as chaves planas residenciais e de veículos.



Customizable V4 clamp (F900-F800)

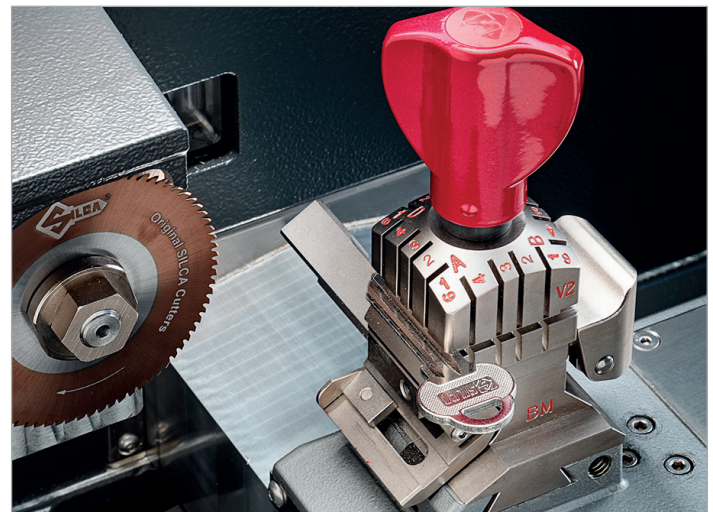

Four-sided V2 clamp (F600-F400)

> More info on [unocodeseries.com](http://unocodeseries.com)

## UNOCODE F SERIES - FEATURES



Unocode F can be connected to external screen, keyboard and mouse

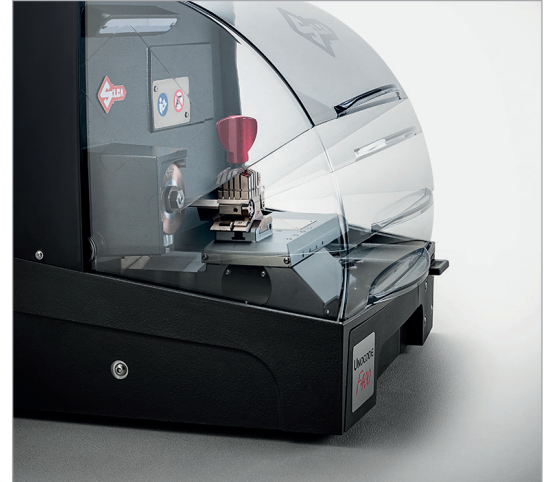

Shield opens and closes automatically



Camera reader (F900-F600-F400)

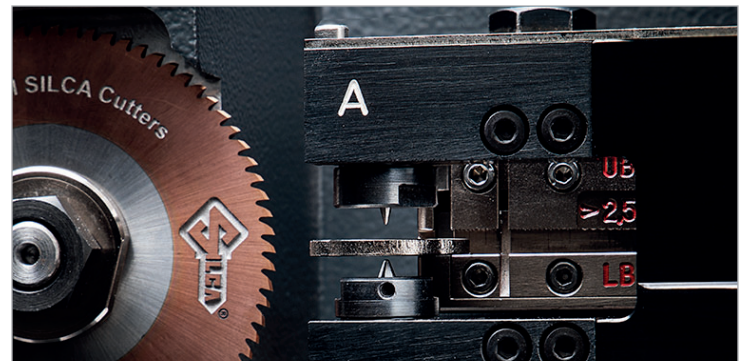

Engraving on both key sides (F900-F800-F600)

## UNOCODE F SERIES - PATENT PENDING FEATURES

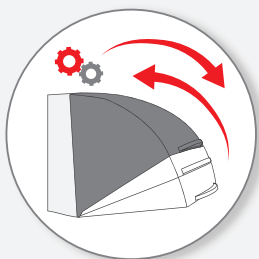

All models

Automatic opening and closing of shield

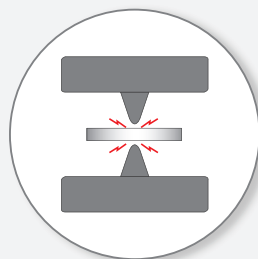

F900-F800-F600

Automatic engraving on both key sides



F900-F600-F400

Integrated camera reader

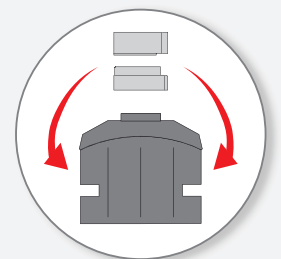

F900-F800

Clamp with two customizable sides

> More info on [unocodeseries.com](http://unocodeseries.com)



## UNOCODE F SERIES - BENCHMARK



Models Features	F900	F800	F600	F400
Copy by code	✓	✓	✓	✓
Decoding and copy by original	✓	x	✓	✓
Engraving	✓	✓	✓	x
Automatic feeding and sorting	✓	✓	Optional	Optional

Visit [unocodeseries.com](http://unocodeseries.com)

FOR MORE NEWS, BROCHURES, VIDEOS, INTERVIEWS AND MORE...

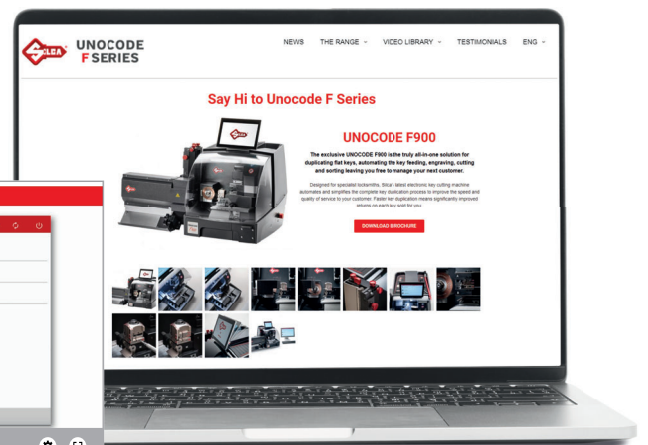
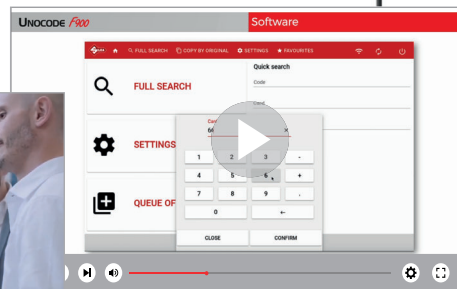

> More info on [unocodeseries.com](http://unocodeseries.com)



## Update 1/2021 - SKP PRO Vers. 31.0.x.xx

### UPDATE 1/2021

**New SKP PRO 1/2021 Update** for all WEB and DVD subscribers available in the "News" section of Silca Key Programs PRO. Follow the path:

*Home>PRODUCTS & SOLUTIONS>Silca Software>SKP PRO>News*

The update includes:

- **Management of the new UNOCODE F Series electronic key cutting machines (F900, F800, F600, F400)**
- Silca Code Program data update
- Silca Triax - Quattrocode Program data update
- Silca Key Reader Program & Optika data update

### MISE À JOUR 1/2021

**Nouvelle mise à jour SKP PRO 1/2021** pour tous les abonnés WEB et DVD disponible dans la section "Nouveautés" de Silca Key Programs PRO. Suivez le lien : *Home>PRODUITS & SOLUTIONS>Silca Software>SKP PRO>Nouveautés*

La mise à jour comprend :

- **Gestion des nouvelles machines de la Série UNOCODE F (F900, F800, F600, F400)**
- Mise à jour des données pour Silca Code Program
- Mise à jour des données pour Silca Triax - Quattrocode Program
- Mise à jour des données pour Silca Key Reader Program & Optika

### AGGIORNAMENTO 1/2021

**Nuovo Aggiornamento SKP PRO 1/2021** per tutti gli abbonati WEB e DVD consultabile nella sezione "Novità" di Silca Key Programs PRO. Segui il percorso:

*Home>PRODOTTI & SOLUZIONI>Silca Software>SKP PRO>Novità*

L'aggiornamento comprende:

- **Gestione nuove duplicatrici della Serie UNOCODE F (F900, F800, F600, F400)**
- Aggiornamento dati Silca Code Program
- Aggiornamento dati Silca Triax - Quattrocode Program
- Aggiornamento dati Silca Key Reader Program & Optika

### ACTUALIZACIÓN 1/2021

**Nueva actualización SKP PRO 1/2021** para todos los abonados WEB y DVD disponible en la sección "Novedades" de Silca Key Programs PRO. Sigue el link: *Home>PRODUCTOS Y SOLUCIONES>Silca Software>SKP PRO>Novedades*

La actualización incluye:

- **Gestión de las nuevas duplicadoras de la Serie UNOCODE F (F900, F800, F600, F400)**
- Actualización datos para Silca Code Program
- Actualización datos para Silca Triax - Quattrocode Program
- Actualización datos para Silca Key Reader Program & Optika

### AKTUALISIERUNG 1/2021

Die Informationen zur **neuen Aktualisierung des SKP PRO 1/2021** für alle WEB und DVD Abonnenten ist in der Sektion "Neuheiten" des Silca Key Programs PRO verfügbar. Folgen Sie dem Link:

*Home>PRODUKTE & LÖSUNGEN>Silca Software>SKP PRO>Neuheiten*

Das Update enthält:

- **Verwaltung der neuen Schlüsselräs-maschinen der UNOCODE F-Serie (F900, F800, F600, F400)**
- Datenaktualisierung für Silca Code Program
- Datenaktualisierung für Silca Triax - Quattrocode Program
- Datenaktualisierung für Silca Key Reader Program & Optika

### ATUALIZAÇÃO 1/2021

**Nova atualização SKP PRO 1/2021** para todos os assinantes WEB e DVD disponível na seção "Novidades" de Silca Key Programs PRO. Siga o link:

*Home>PRODUTOS E SOLUÇÕES>Silca Software>SKP PRO>Novidades*

A atualização inclui:

- **Gestão das novas duplicadoras da Série UNOCODE F (F900, F800, F600, F400)**
- Atualização de dados para Silca Code Program
- Atualização de dados para Silca Triax - Quattrocode Program
- Atualização de dados para Silca Key Reader Program & Optika

## SILCA CODE PROGRAM

## SKP PRO Vers. 31.0.x.xx



UC199



Unocode 299



Unocode 399



Unocode 399 Evo



Unocode Pro



Unocode F Series

Data update with 10 new cutting cards / Aggiornamento dati con 10 nuove schede / Datenaktualisierung mit 10 neuen Karten / Mise à jour des données avec 10 nouvelles fiches / Actualización datos con 10 fichas nuevas / Atualização de dados com 10 fichas novas.

New items include / Tra le novità / Unter den Neuheiten / Parmi les nouveautés / Entre las novedades / Entre as novidades:

- Assa®
- Gege®
- Royal Enfield®
- Era®
- Mahindra®
- Star®
- Eurospec®
- Ntorq®
- Yale®



Update the software on / Aggiornare il software di / Aktualisierung der Software von / Mettre à jour le logiciel de / Actualizar el software de / Atualizar o software de: UC199, Unocode 299, Unocode 399, Unocode 399 Evo, Unocode Pro, Unocode F Series.

## SILCA TRIAX - QUATTROCODE PROGRAM

## SKP PRO Vers. 31.0.x.xx



Quattrocode



Triax-e.code



Triax Quattro



Triax Pro

Data update with 21 new series / Aggiornamento dati con 21 nuove serie / Datenaktualisierung mit 21 neuen Serien / Mise à jour des données avec 21 nouvelles séries / Actualización datos con 21 nuevas series / Atualização de dados com 21 novas séries.

New items include / Tra le novità / Unter den Neuheiten / Parmi les nouveautés / Entre las novedades / Entre as novidades:

- Cisa®
- Iseo®
- Tata®
- Dom® (only for Triax Program)
- Mul.T.Lock®
- Yale®
- Federal®
- Omec®



Update the software on / Aggiornare il software di / Aktualisierung der Software von / Mettre à jour le logiciel de / Actualizar el software de / Atualizar o software de: Triax e-code, Triax Quattro, Triax Pro.

## SILCA KEY READER PROGRAM & OPTIKA

## SKP Vers. 31.0.x.xx



Optika

Update with more than 120 new references.

Remember to use a USB PEN to update the OPTIKA program. To download from the USB-PEN use the "Advanced" function in the OPTIKA "Archives =>Machines" of the Key Reader Program (or SKP).

Aktualisierung mit über 120 neuen Referenzen.

Nicht vergessen, das Programm OPTIKA mit dem USB-PEN zu aktualisieren. Zum Laden der USB-PEN die Funktion "Optionen" der "Daten =>Maschinen => Optika" Key Reader Program (oder SKP) verwenden.

Actualización con más de 120 referencias nuevas.

Acordarse de actualizar el programa de OPTIKA utilizando el USB-PEN. Para cargar el USB-PEN utilizar la función "Avances" del "Tabla máquinas" OPTIKA del Key Reader Program (o SKP).

Aggiornamento con più di 120 referenze.

Ricordarsi di aggiornare il programma di OPTIKA utilizzando una USB-PEN. Per caricare la USB-PEN utilizzare la funzione "Avanzate" dell' "Anagrafica macchine" OPTIKA del Key Reader Program (o SKP).

Mise à jour avec plus de 120 nouvelles références.

N'oubliez pas de mettre à jour le programme d'OPTIKA en utilisant une USB-PEN. Pour charger la USB-PEN, utiliser la fonction « Avancées » dans le menu « Fichier machines » OPTIKA du Key Reader Program (ou SKP).

Atualização com mais de 120 referências novas.

Lembrar de atualizar o programa de OPTIKA utilizando uma USB-PEN. Para carregar a USB-PEN utilizar a função "Avançar" de "Tabela máquinas" OPTIKA do Key Reader Program (ou SKP).

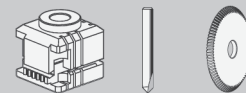

Accessories / Accessori / Zubehör / Accessoires / Accesorios / Acessórios

FOR:  
PER:

## ASSA (SE)

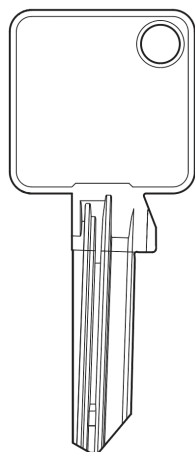

(VRS)

IKON

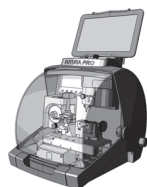

**FUTURA PRO**  
FUTURA



**UNOCODE PRO**  
>SW 3.0.032



**UNOCODE 399 EVO**  
>SW 2.3.072

**UNOCODE 299**  
**UNOCODE 399**  
>SW 4.5.140

OPTIONAL



### D7A4369ZB

*B17 Adapter*  
*Adattatore B17*  
*Adapter B17*  
*Adaptateur B17*  
*Adaptador B17*  
*Adaptador B17*

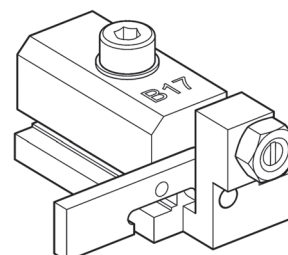

FOR:  
PER:

# UNOCODE

## F400 F600

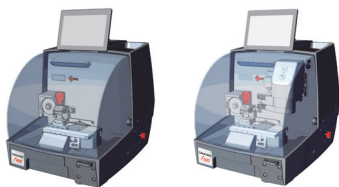

OPTIONAL



**D7A3836ZB**  
V3 clamp  
Morsetto V3  
V3 Spannbacke  
Etau V3  
Mordaza V3  
Mordente V3

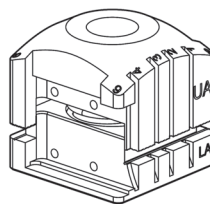

FOR:  
PER:

# CISA (IT)

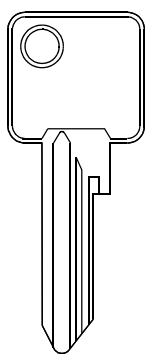

(TSP)

ABUS



UNOCODE F800  
UNOCODE F900

OPTIONAL



**D7A3787ZB**

Jaws set U1-L1  
Set ganasce U1-L1  
Satz Backen U1-L1  
Ens.mâchoires U1-L1  
Juego quijadas U1-L1  
Conjunto de garras U1-L1

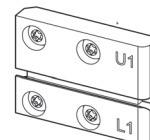

UNOCODE F400  
UNOCODE F600

OPTIONAL



**D7A3787ZB**

Jaws set U1-L1  
Set ganasce U1-L1  
Satz Backen U1-L1  
Ens.mâchoires U1-L1  
Juego quijadas U1-L1  
Conjunto de garras U1-L1

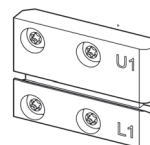

OPTIONAL



**D7A3836ZB**

V3 clamp  
Morsetto V3  
V3 Spannbacke  
Etau V3  
Mordaza V3  
Mordente V3

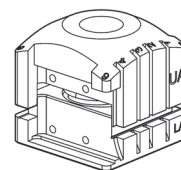

FOR:  
PER:

# CISA (IT)

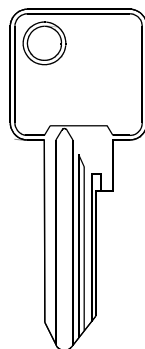

(SP)

ABUS

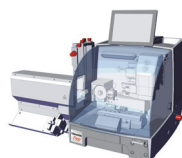

UNOCODE F800  
UNOCODE F900

OPTIONAL



**D7A3835ZB**

Jaws set U2-L2  
Set ganasce U2-L2  
Satz Backen U2-L2  
Ens.mâchoires U2-L2  
Juego quijadas U2-L2  
Conjunto de garras U2-L2

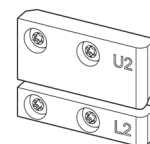

UNOCODE F400  
UNOCODE F600

OPTIONAL



**D7A3835ZB**

Jaws set U2-L2  
Set ganasce U2-L2  
Satz Backen U2-L2  
Ens.mâchoires U2-L2  
Juego quijadas U2-L2  
Conjunto de garras U2-L2

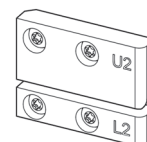

OPTIONAL



**D7A3836ZB**

V3 clamp  
Morsetto V3  
V3 Spannbacke  
Etau V3  
Mordaza V3  
Mordente V3

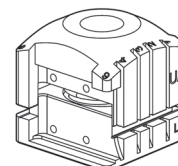

FOR:  
PER:

# ASSA (SE)

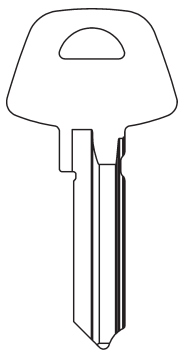

(D-12)

ABLOY



UNOCODE F800  
UNOCODE F900

OPTIONAL



## D7A3824ZB

Jaws set U3-L3  
Set ganasce U3-L3  
Satz Backen U3-L3  
Ens.mâchoires U3-L3  
Juego quijadas U3-L3  
Conjunto de garras U3-L3

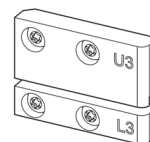

UNOCODE F400  
UNOCODE F600

OPTIONAL



## D7A3824ZB

Jaws set U3-L3  
Set ganasce U3-L3  
Satz Backen U3-L3  
Ens.mâchoires U3-L3  
Juego quijadas U3-L3  
Conjunto de garras U3-L3

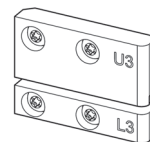

OPTIONAL



## D7A3836ZB

V3 clamp  
Morsetto V3  
V3 Spannbacke  
Etau V3  
Mordaza V3  
Mordente V3

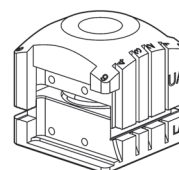

FOR:  
PER:

# ASSA (SE)

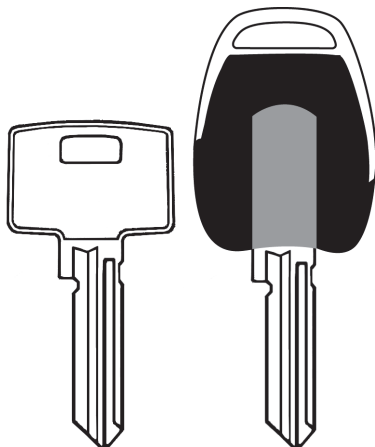

(DP CLIQ)



UNOCODE F800  
UNOCODE F900

OPTIONAL



## D7A3826ZB

Jaws set U4-L4  
Set ganasce U4-L4  
Satz Backen U4-L4  
Ens.mâchoires U4-L4  
Juego quijadas U4-L4  
Conjunto de garras U4-L4

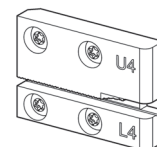

UNOCODE F400  
UNOCODE F600

OPTIONAL



## D7A3826ZB

Jaws set U4-L4  
Set ganasce U4-L4  
Satz Backen U4-L4  
Ens.mâchoires U4-L4  
Juego quijadas U4-L4  
Conjunto de garras U4-L4

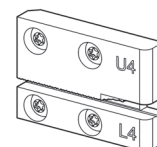

OPTIONAL



## D7A3836ZB

V3 clamp  
Morsetto V3  
V3 Spannbacke  
Etau V3  
Mordaza V3  
Mordente V3

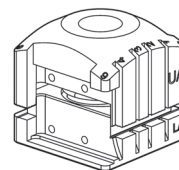

FOR:  
PER:

## DOM (DE)

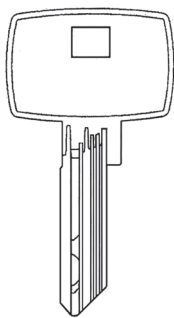

(RS8)



UNOCODE F800  
UNOCODE F900

OPTIONAL



### D7A3830ZB

Jaws set U5-L5  
Set ganasce U5-L5  
Satz Backen U5-L5  
Ens.mâchoires U5-L5  
Juego quijadas U5-L5  
Conjunto de garras U5-L5

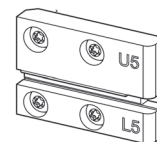

UNOCODE F400  
UNOCODE F600

OPTIONAL



### D7A3830ZB

Jaws set U5-L5  
Set ganasce U5-L5  
Satz Backen U5-L5  
Ens.mâchoires U5-L5  
Juego quijadas U5-L5  
Conjunto de garras U5-L5

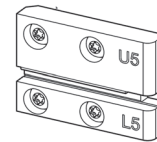

OPTIONAL



### D7A3836ZB

V3 clamp  
Morsetto V3  
V3 Spannbacke  
Etau V3  
Mordaza V3  
Mordente V3

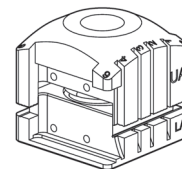

FOR:  
PER:

## ABUS (DE)

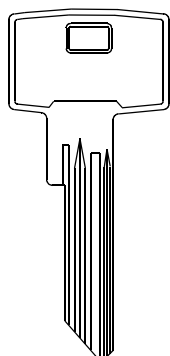

(KV14 - XY14)

(KV14 - XV14)

( Vitess 1000 - 2000 - 4000 )

PFAFFENHAIN



UNOCODE F800  
UNOCODE F900

OPTIONAL



### D7A3997ZB

Jaws set U6-L6  
Set ganasce U6-L6  
Satz Backen U6-L6  
Ens.mâchoires U6-L6  
Juego quijadas U6-L6  
Conjunto de garras U6-L6

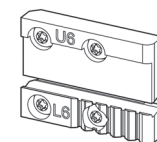

UNOCODE F400  
UNOCODE F600

OPTIONAL



### D7A3997ZB

Jaws set U6-L6  
Set ganasce U6-L6  
Satz Backen U6-L6  
Ens.mâchoires U6-L6  
Juego quijadas U6-L6  
Conjunto de garras U6-L6

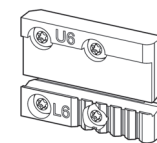

OPTIONAL



### D7A3836ZB

V3 clamp  
Morsetto V3  
V3 Spannbacke  
Etau V3  
Mordaza V3  
Mordente V3

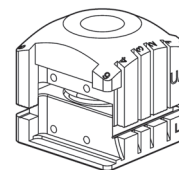

FOR:  
PER: **WINKHAUS (DE)**

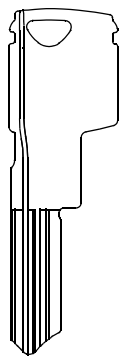

(RPE - RPS)



**UNOCODE F800**  
**UNOCODE F900**

OPTIONAL



**D7A4000ZB**

Jaws set U7-L7  
Set ganasce U7-L7  
Satz Backen U7-L7  
Ens.mâchoires U7-L7  
Juego quijadas U7-L7  
Conjunto de garras U7-L7

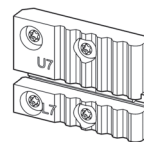

**UNOCODE F400**  
**UNOCODE F600**

OPTIONAL



**D7A4000ZB**

Jaws set U7-L7  
Set ganasce U7-L7  
Satz Backen U7-L7  
Ens.mâchoires U7-L7  
Juego quijadas U7-L7  
Conjunto de garras U7-L7

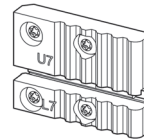

OPTIONAL



**D7A3836ZB**

V3 clamp  
Morsetto V3  
V3 Spannbacke  
Etau V3  
Mordaza V3  
Mordente V3

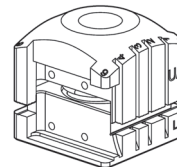

FOR:  
PER: **UNOCODE**  
*F400 F600*

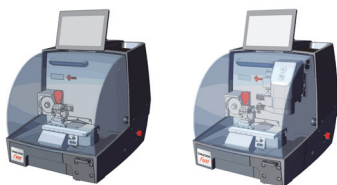

OPTIONAL

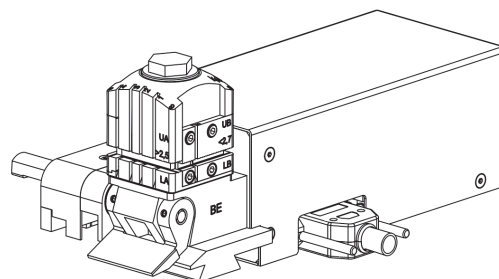

**D9A4014ZR**

V4+BE electric clamp  
Morsetto elettrico V4+BE  
V4+BE Elektrische Spannbacke  
Etau électrique V4+BE  
Mordaza eléctrica V4+BE  
Mordente eléctrico V4+BE





FOR:  
PER:

# UNOCODE F400 F600

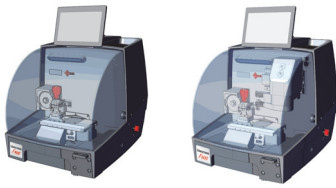

OPTIONAL

NEW

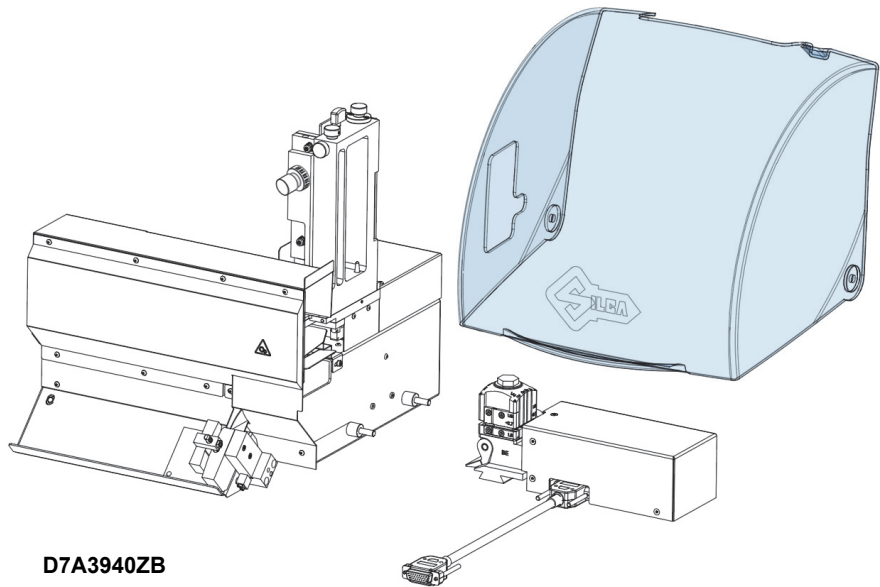

## D7A3940ZB

*Kit Feeder Unocode F*  
*Set Alimentatore Unocode F*  
*Zuführungseinheit Unocode F*  
*Kit Alimentateur Unocode F*  
*Grupo Alimentador Unocode F*  
*Conjunto Alimentador Unocode F*

FOR:  
PER:

# KIT FEEDER Unocode F

OPTIONAL

NEW

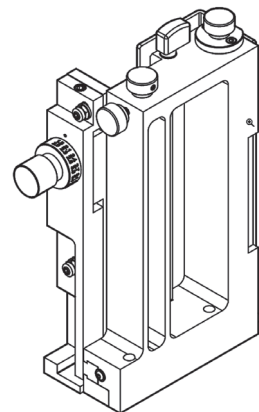

## D9A3415ZR

*Top feeder*  
*Caricatore dall'alto*  
*Top-Magazin*  
*Chargeur par le haut*  
*Cargador por arriba*  
*Carregador do alto*

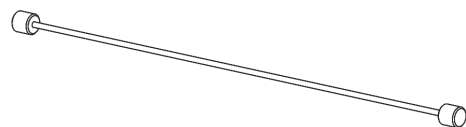

## D9A4404ZR

*Keys unloading rod*  
*Asta per scarico chiavi*  
*Stange zum Schlüsseln ablagen*  
*Tige pour déchargement clés*  
*Barra descarga llaves*  
*Vara descarga chaves*